

audison

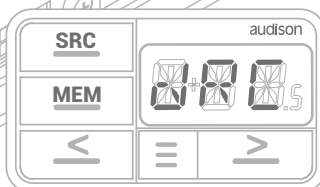
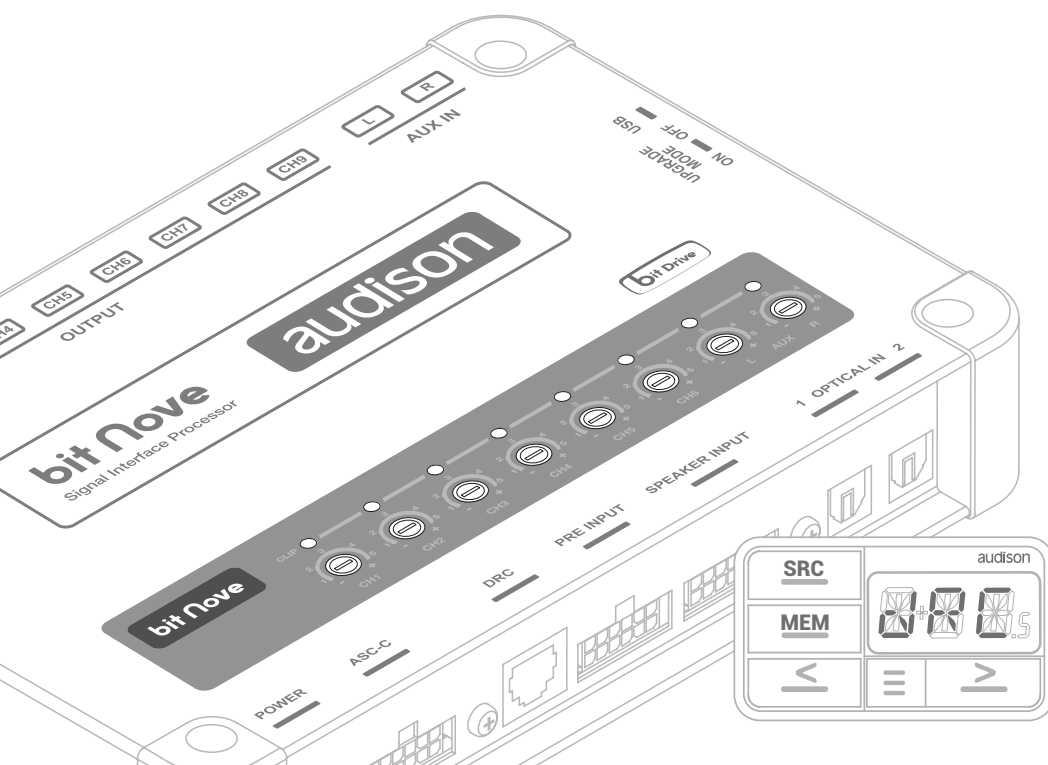

bit

bit Nove

Signal Interface Processor

USER'S MANUAL

rev. 1.0 a



ideato,
progettato,
costruito
in Italia

Index

1. PRODUCT DESCRIPTION / PRECAUTIONS	3
2. PACKAGE CONTENTS	3
3. BIT NOVE and DRC INSTALLATION	4
4. CONNECTION PANEL DESCRIPTION	5
1 LOGO STATUS	5
2 POWER AND CONTROL CABLE	6
3 PRE INPUT	7
4 SPEAKER OUT	7
5 OPTICAL IN 1/2: S/PDIF DIGITAL INPUTS	8
6 AUX: LOW-LEVEL AUXILIARY STEREO INPUT	8
7 PRE OUT: LOW-LEVEL ANALOG SIGNAL (4 Volts RMS)	8
8 INPUT LEVEL	8
9 DRC	8
10 USB	8
11 UPGRADE MODE	8
12 ASC-C	8
5. CONNECTIONS	9
5.1 POWER SUPPLY AND REMOTE TURN ON	9
5.2 INPUT SIGNALS	10
5.3 DIGITAL OPTICAL IN INPUT SIGNALS	14
5.4 OUTPUT SIGNALS	15
5.5 PERSONAL COMPUTER AND DIGITAL REMOTE CONTROL (DRC)	16
6. GUIDE FOR INSTALLING/UNINSTALLING BIT NOVE SOFTWARE AND DRIVERS	17
6.1 GUIDED PROCEDURE FOR PC SOFTWARE INSTALLATION	17
6.2 GUIDED PROCEDURE FOR DRIVER INSTALLATION	19
6.3 UNINSTALLING BIT NOVE SOFTWARE	19
7. HOW TO SET UP THE BIT NOVE USING A PC	20
7.1 OFFLINE MODE	20
7.2 TARGET MODE	21
7.3 ADJUSTING ACOUSTIC REPRODUCTION	27
7.3.1 DEVICE INFO	27
7.3.2 FILE MAIN MENU	28
7.3.3 MEMORIES MAIN MENU	28
7.3.4 SETTINGS MAIN MENU	29
7.3.5 DEVICE MAIN MENU	31
7.3.6 HELP MAIN MENU	32
7.3.7 SELECTED INPUT	32
7.3.8 CHANNEL MAP	32
7.3.9 SELECT CHANNEL	33
7.3.10 FILTER SETTINGS	33
7.3.11 SET DISTANCE AND DELAY	35
7.3.12 PARAMETRIC EQUALIZER	38
7.3.13 OUTPUT LEVEL	39
7.3.14 MEMORY	39
7.3.15 STATUS BAR	39
8. TROUBLESHOOTING	40
8.1 SYNCHRONIZATION WITH A PC	40
8.2 BACKGROUND NOISE	40
8.3 FIRMWARE UPGRADE	41
8.3.1 TARGET MODE UPDATE	41
8.3.2 RESCUE MODE UPDATE	42
9. TECHNICAL SPECIFICATIONS	44

1. PRODUCT DESCRIPTION / PRECAUTIONS

The **bit Nove** is a digital signal processor essential to maximize the acoustic performance of a car audio system. It features a 32-bit DSP processor with 24-bit A/D and D/A converters. It can be interfaced to any OEM system, even on vehicles equipped with integrated sound processor, since thanks to the de-equalization function, the **bit Nove** will deliver a linear signal. It is equipped with 10 input signals, 6 Hi-Level/ Pre In, 1 Aux stereo, 2 digital Tos Link S-PDIF and provides 9 PRE OUT analog outputs.

Each output channel is provided with: an equalization group graphically adjustable, a 68 steps frequency electronic crossover and Butterworth or Linkwitz-Riley type filters with slopes from 6 to 24 dB / Oct and a time-delay line.

The **bit Nove** also features preset configurations which can be selected by the user via the remote control device DRC AB.

- WARNING:**  **1.** To install the software and configure the product it is necessary to use a PC with Windows Vista, Windows 7 or Windows 8 operating system, minimum 2 GHz processor, 1 GB RAM and a graphic card with a minimum resolution of 1024 x 600 pixel and 512 MB hard disk memory available or more.
- 2.** Read this manual carefully before connecting the product. Failure to comply with the instructions herein may cause damage to the **bit Nove** or the car audio system speakers.

2. PACKAGE CONTENTS

- **bit Nove**

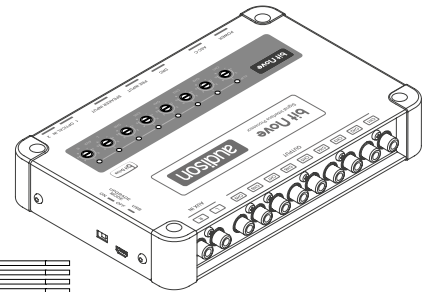

- Multipolar cable, Inputs:



- Multipolar cable, Power:



- 1.8 m USB cable:

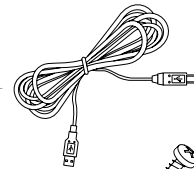

- 4 4.2 x 50 mm self-tapping, cross head mounting screws:

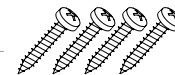

- CD ROM containing:
bit Nove Software
This owner's manual (.pdf)
Audio Test Tracks



- Quick start guide



- Warranty



OPTIONAL:

- DRC AB + Mounting Kit

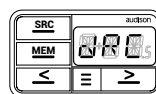

+

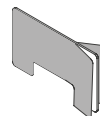

+



3. BIT NOVE AND DRC INSTALLATION

External Size

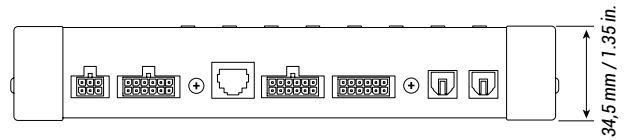
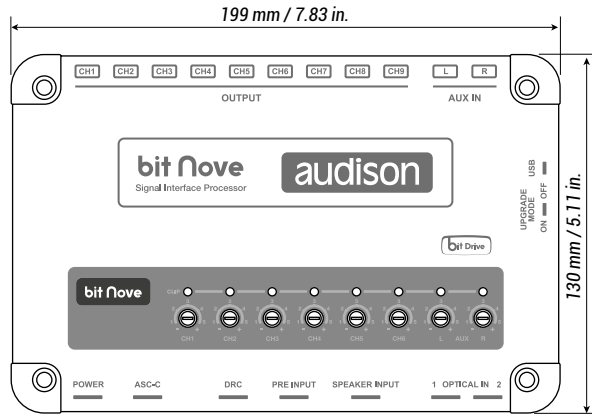

Mounting Size

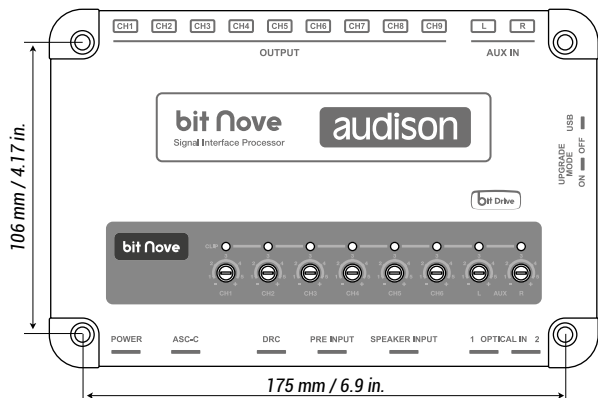

How to mount

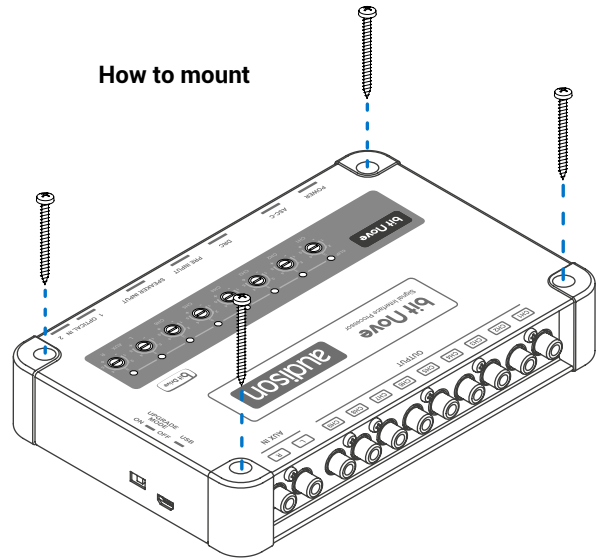

DRC AB (optional) Installation

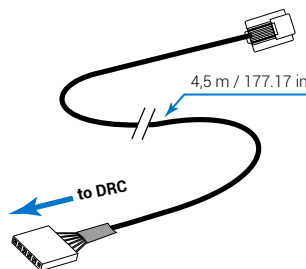
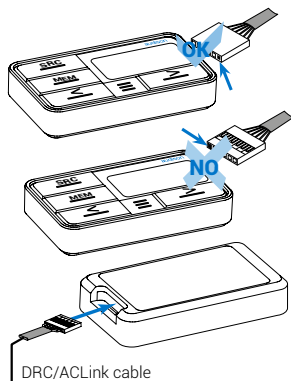
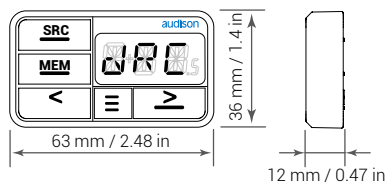

Fixing

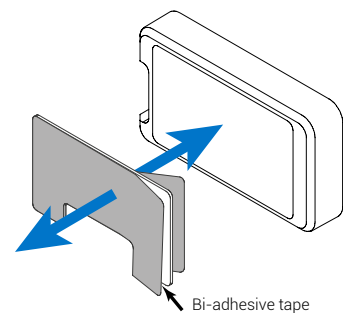

4. CONNECTION PANELS - DESCRIPTION

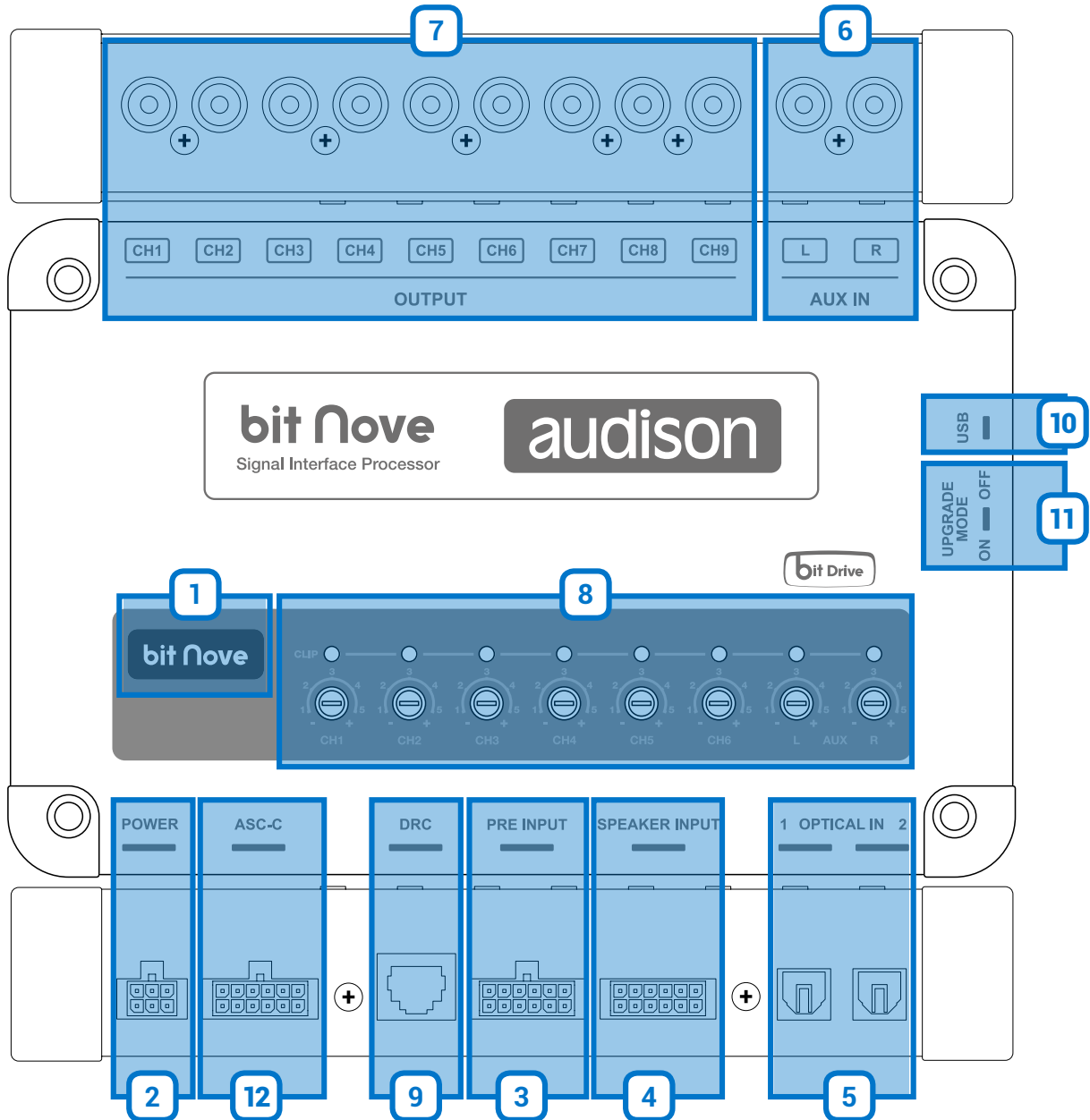

1 LOGO STATUS

The logo led light indicates the processor status:

- **BLUE Logo On:** bit Nove is switched on.
- **Flashing BLUE Logo:** product mode set to Upgrade Mode ON, or product being updated (see section 4.11).

2 POWER and CONTROL CABLE

The **bit Nove** is equipped with a 6-pole multipolar connector to manage the power supply and the different control connections.

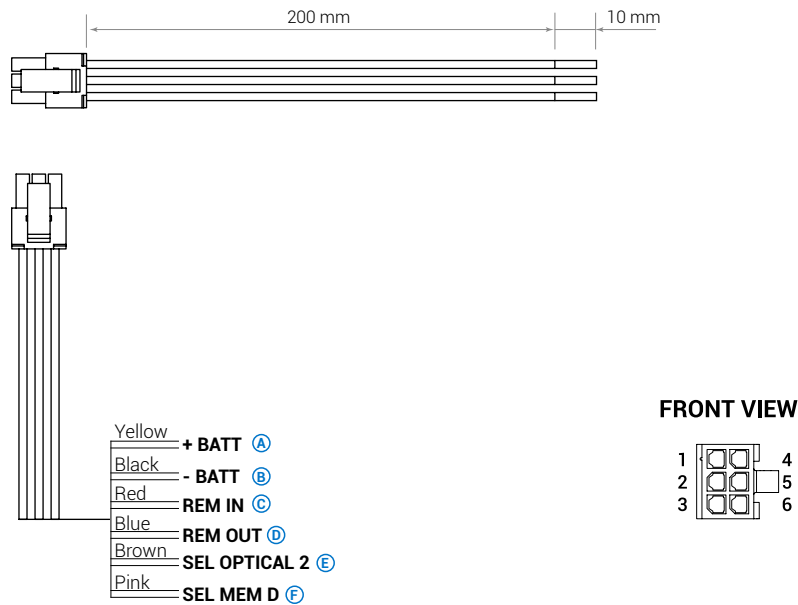

A) + BATT (11-15 VDC): terminal to connect the power supply positive pole to the bit Nove.

B) - BATT (Ground): terminal to connect the processor's power supply negative pole. Connect the negative battery cable or a cable connected to the car's chassis.

To fix the ground connection (-) correctly use a screw already available on the vehicle's chassis; remove any paint or grease residue if necessary, ensuring that there is a continuity between the negative terminal (-) of the battery and the fixing point. If possible, connect all audio components grounds to the same point as this solution is necessary to reduce the majority of parasitic noises which may arise during reproduction.

WARNING: observing the polarity of the connection as indicated on the terminals is essential. An incorrect connection may cause damage to the bit Nove. After switch on, wait at least 10 seconds before turning the processor on.



C) REM IN: terminal to turn on the bit Nove via the Remote Out output of the audio signal source. The applied voltage must be between 7 and 14.5 VDC. If you are using a source with BTL amplified outputs, the bit Nove can turn on automatically (see section 7.3.4.6), so you will not need to connect the REM IN terminal.

D) REM OUT: output terminal for the remote turn on of other devices/amplifiers connected to the bit Nove. The processor takes 2 seconds to provide the REM OUT to the output, but you can manually set this delay with the software (see section 7.3.4.6). This output has a current capacity of 150 mA and can drive an automotive relay.

E) OPTICAL 2 SELECT: function to select the OPTICAL IN 2 input. This command is enabled by connecting the terminal at + 12V.

F) SEL MEM D: function to enable the manual selection of the processor's preset D. This command is enabled by connecting the terminal to ground.

3 PRE INPUT

The **bit Nove** features 6 **Pre IN** signal inputs to connect the preamplified signal cables from the analog Master source. The PC Software provides the ability to customize the inputs by assigning the desired input ([see 7.2.5](#)). Adjustable sensitivity from 1.2 to 8 V RMS ([see 4.8](#)). The cable provided to be connected to the source Pre Out outputs must be wired with RCA connectors, or replaced with an optional input cable.

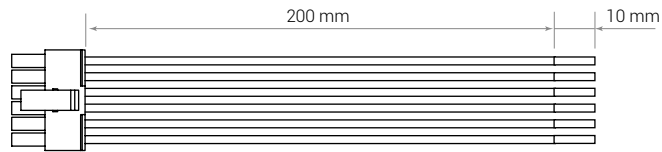

FRONT VIEW

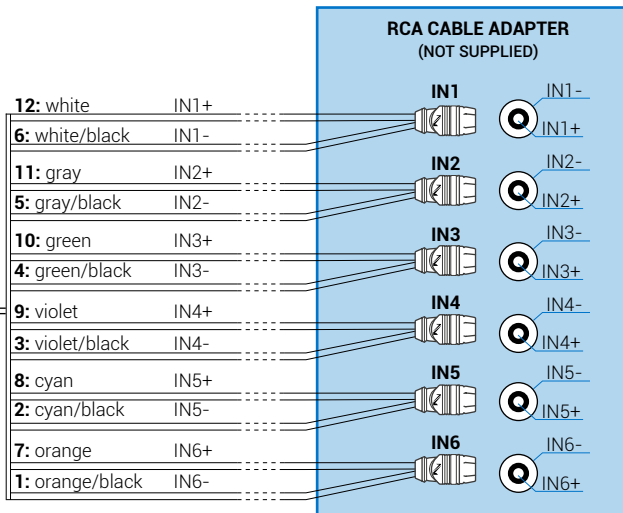
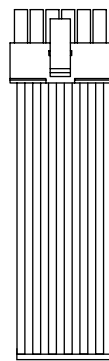
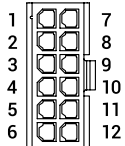

4 SPEAKER INPUT

The **bit Nove** features 6 **SPEAKER IN** signal inputs to connect the amplified signal cables from the analog master source. The PC Software provides the ability to customize the inputs by assigning the desired input ([see 7.2.5](#)). Adjustable sensitivity from 3 to 20 V RMS ([see 4.8](#)).

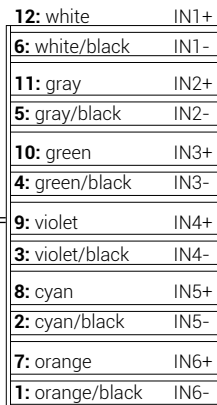
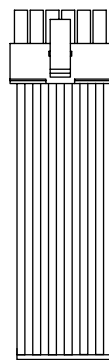

FRONT VIEW

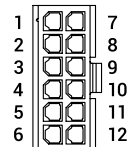

5 OPTICAL IN 1/2: S/PDIF digital inputs

The **bit Nove** accepts PCM input signals with a maximum sampling frequency of up to 192 kHz 24 bits, therefore it is not possible to reproduce DOLBY DIGITAL (AC3) coded multichannel signals from audio/video sources (such as the audio from a movie on DVD) or DTS (see section 4.2). The selection of these inputs is possible by using the DRC external control or by activating it through the terminals.

OPTICAL 1. Connect a fiber optical cable with TOSLINK connector.

OPTICAL 2. Connect a fiber optical cable with TOSLINK connector.

Remark: during the fiber optical cables wiring, the minimum curve radius should be 40 mm.

A bending above this value will cause the cable to break and the consequent interruption of the digital signal.

6 AUX: low-level auxiliary STEREO input

For RCA cables coming from additional analog signal sources. Adjustable sensitivity from 0.2 to 4.2 V RMS (point 8).

7 PRE OUT: low-level analog signal (4 Volts RMS)

Ch1 - Ch2 - Ch3 - Ch4 - Ch5 - Ch6 - Ch7 - Ch8 - Ch9. For RCA cables directed to the system amplifiers (see 5.4).

WARNING: by default, the bit Nove outputs are customized as described in (see 5.4). Therefore, before connecting



the amplifiers to the bit Nove, check the outputs configuration or perform a new configuration depending on your audio system.

8 INPUT LEVEL:

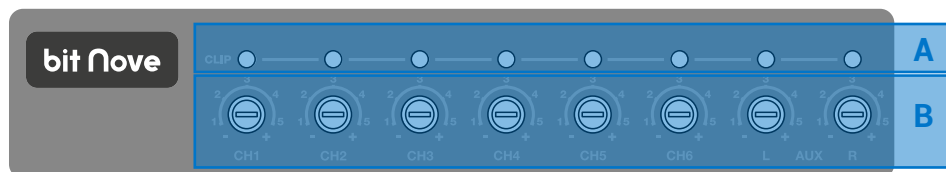

A. CLIP: input clipping indicator (see 7.2.6). The led light on indicates the presence of clipping on the selected input.

B. IN level: input signal level controls. Turning the sliders anti-clockwise the input sensitivity decreases, turning them clockwise it increases. This adjustment is important for obtaining a good noise/signal ratio and optimizing your audio system.

9 DRC: connection socket for the DRC (DRC MP optional) to set up the most important functions of the processor.

10 USB: USB (B type) connection socket to connect the processor to a PC and manage the functions through the **bit Nove** software.

11 UPGRADE MODE: the switch to ON position enables the update of the product in RESCUE MODE (see 8.3.1).

12 ASC-C: socket not enabled, to be used for future applications.

5. CONNECTIONS

5.1 POWER SUPPLY AND REMOTE TURN ON

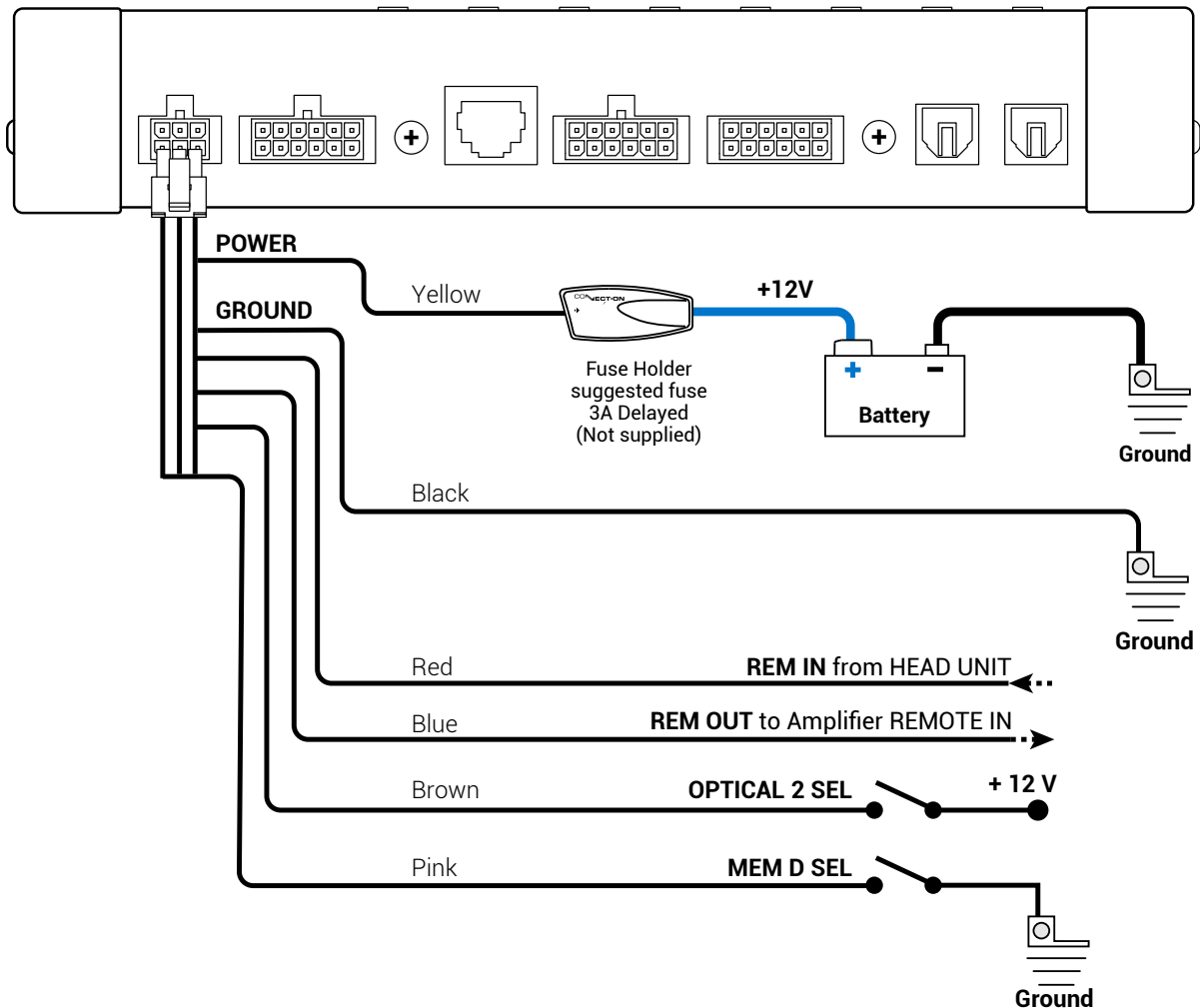

Turn bit Nove on and off

bit Nove is on when the logo is lit blue. It can be turned on/off using the following methods:

1. By pressing on the main DRC SRC key. By holding down the DRC SRC key (OFF).
In this case, no other Remote In connections are needed, but they can co-exist.
2. By connecting the REMOTE IN terminal with a Remote Out signal coming from an after market audio source.
3. Through the Hi Level MASTER (IN 1 - IN 2) input. The AUTO TURN ON (ART) function is activated by connecting the output of an amplified source to the INPUT IN 1 - IN 2 input channel. This function can be enabled/disabled using the **bit Nove** PC software ([see sec. 7.3.4.6](#)).

5.2 INPUT SIGNALS

1. HI-LEVEL INPUTS FRONT + REAR



PC Software configuration (see sec. 7.2.5)

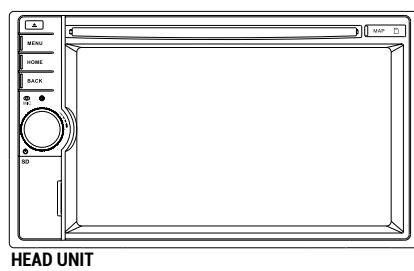
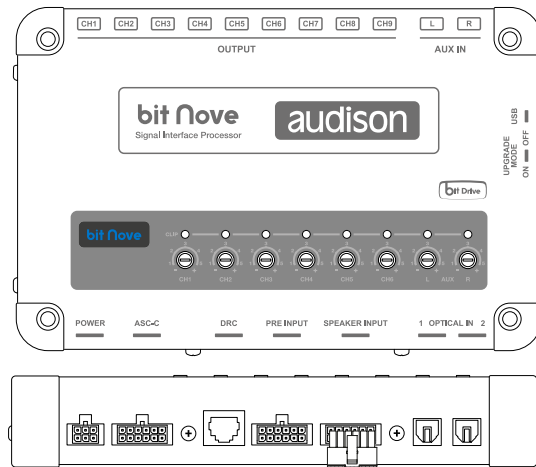

HEAD UNIT

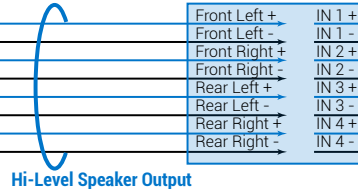

Hi-Level Speaker Output

Input sensitivity
3 ÷ 20 VRMS

2. HI-LEVEL INPUTS TWO WAY FRONT + REAR



PC Software configuration (see sec. 7.2.5)

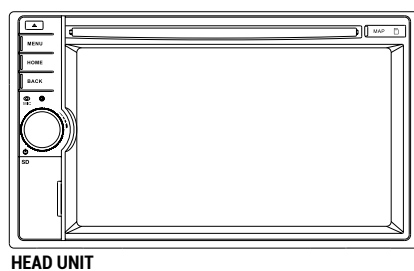
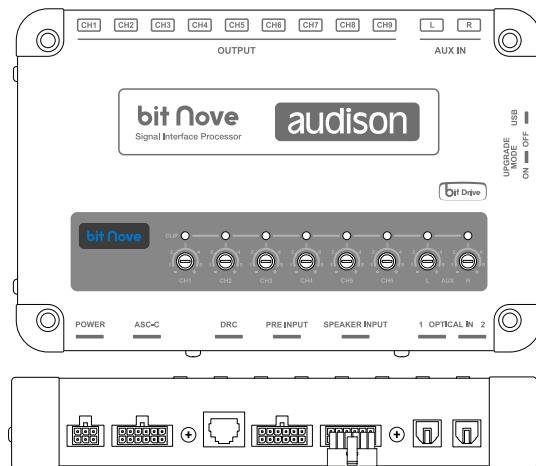

HEAD UNIT

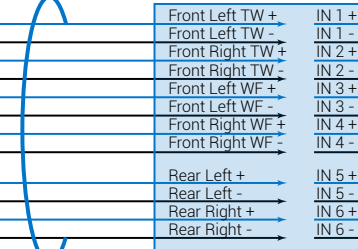

Hi-Level Speaker Output

Input sensitivity
3 ÷ 20 VRMS

3. HI-LEVEL INPUTS THREE WAY FRONT + REAR



PC Software configuration (see sec. 7.2.5)

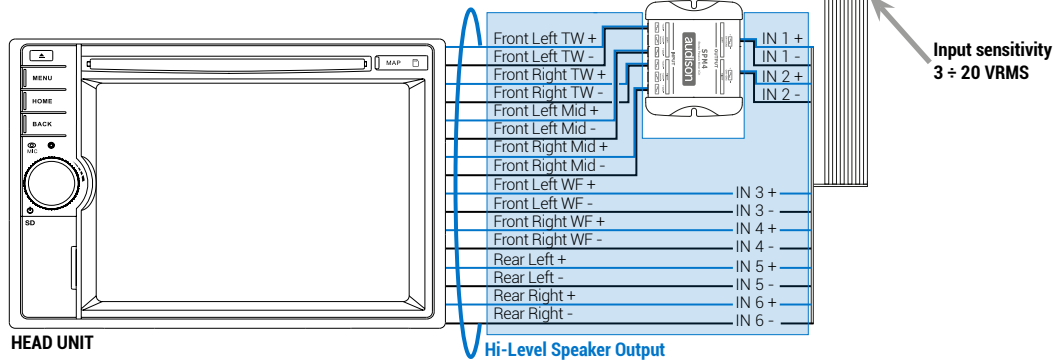
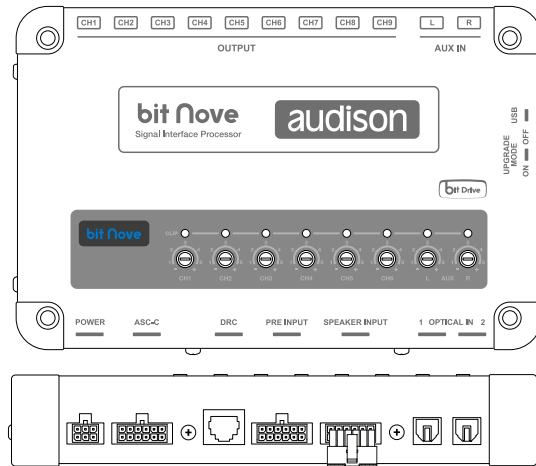

4. HI-LEVEL INPUTS TWO WAY FRONT + REAR + CENTER + SUB



PC Software configuration (see sec. 7.2.5)

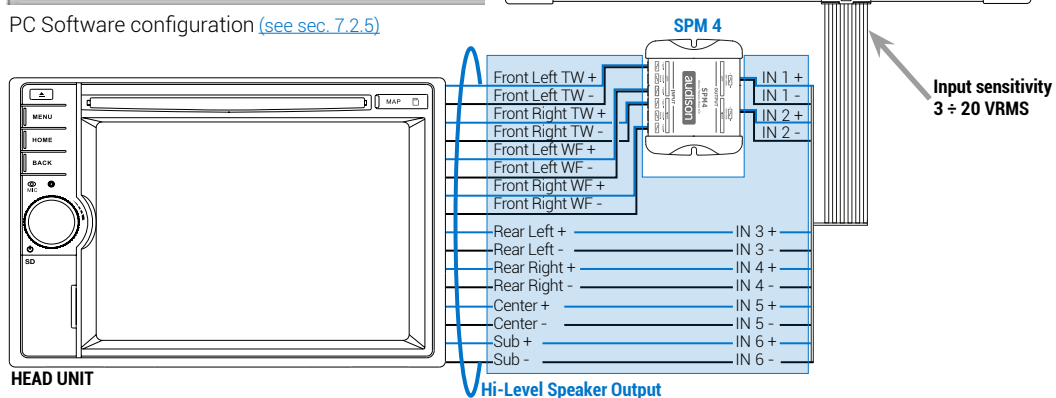
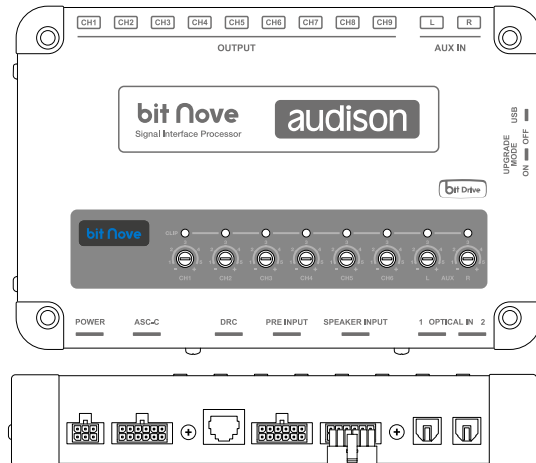

5. HI-LEVEL INPUTS FRONT + REAR + CENTER + SUB

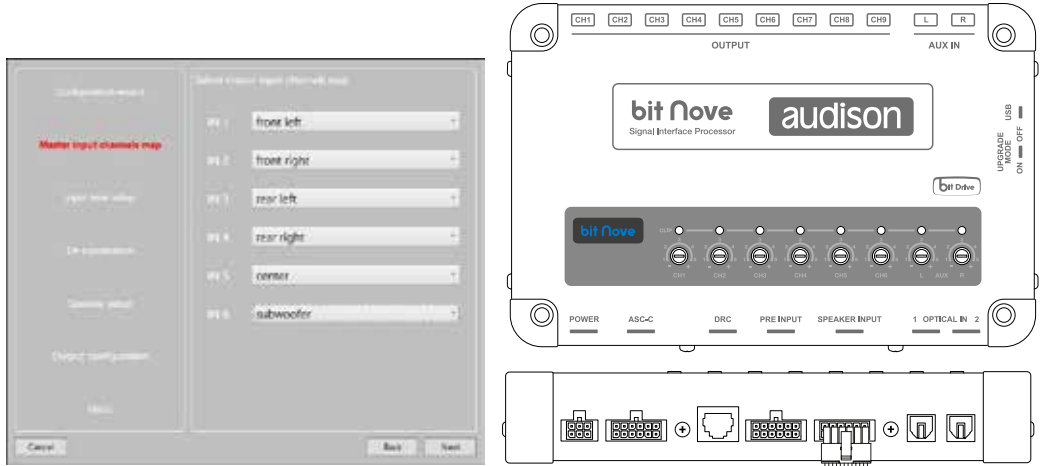

PC Software configuration (see sec. 7.2.5)

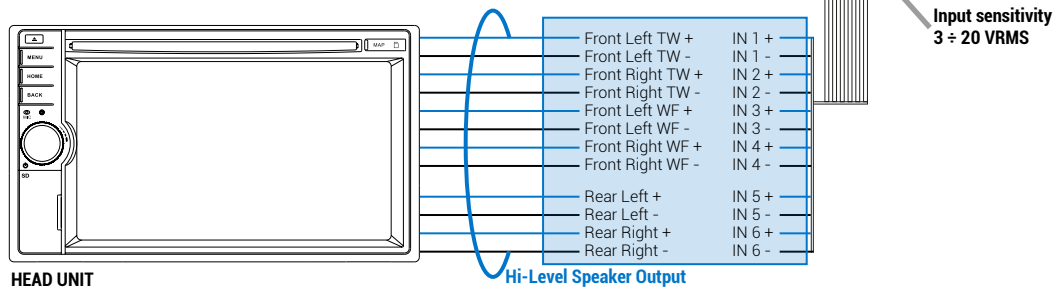

6. PRE INPUTS FRONT + REAR

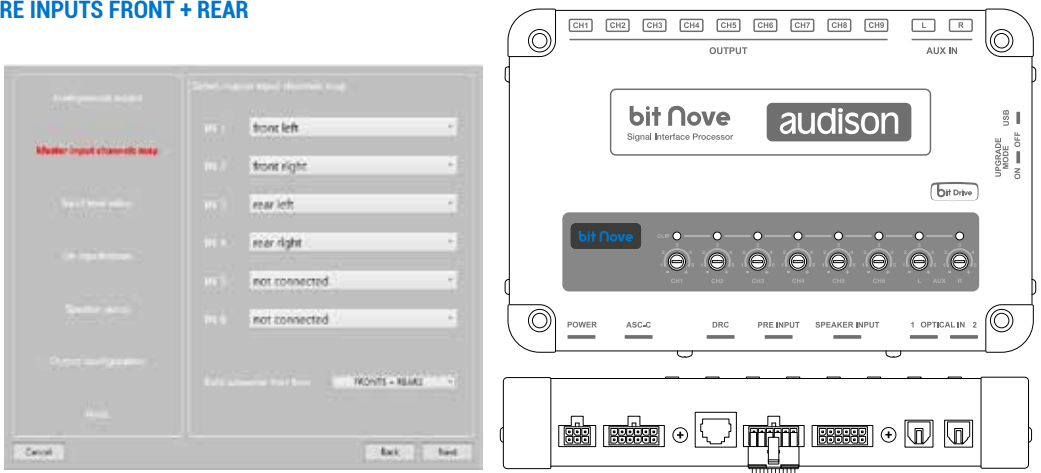

PC Software configuration (see sec. 7.2.5)

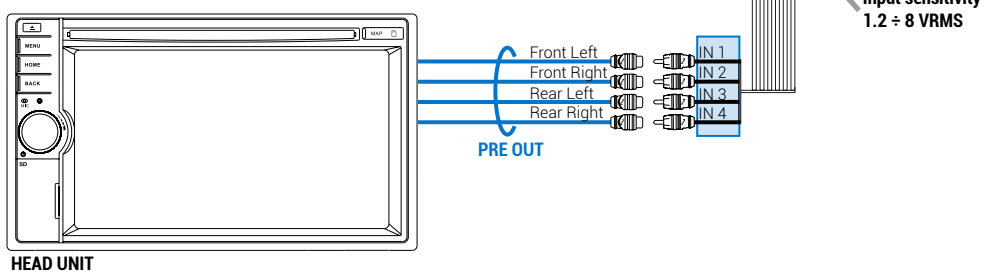

7. PRE INPUTS TWO WAY FRONT + CENTER + SUB



PC Software configuration (see sec. 7.2.5)

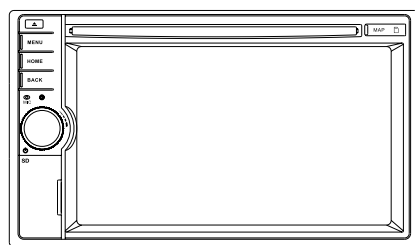
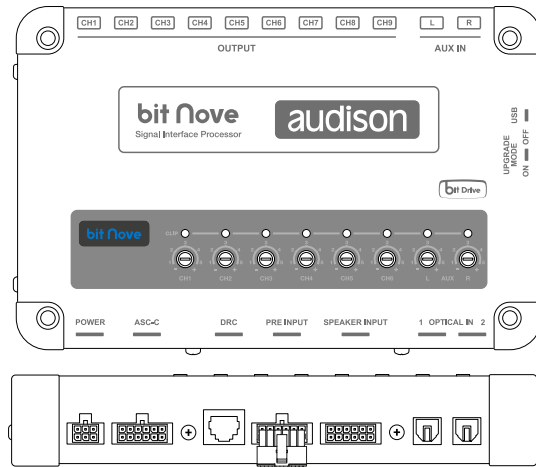

HEAD UNIT

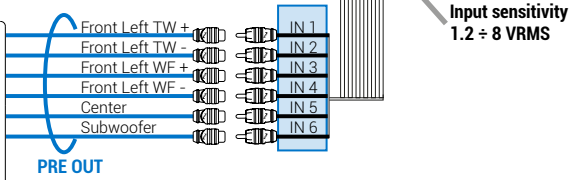

8. PRE INPUTS FRONT + REAR + CENTER + SUB



PC Software configuration (see sec. 7.2.5)

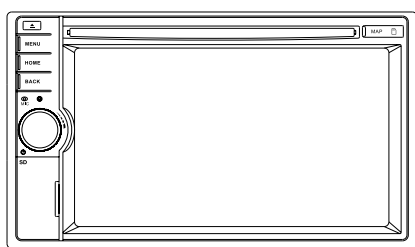
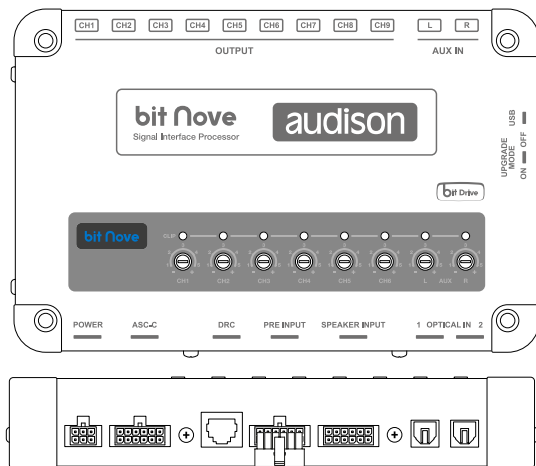

HEAD UNIT

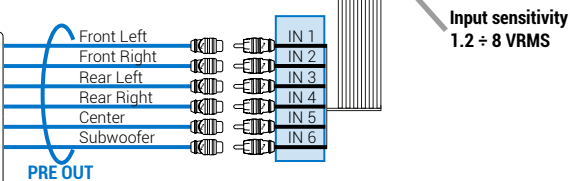

9. AUX, ANALOG STEREO SIGNAL

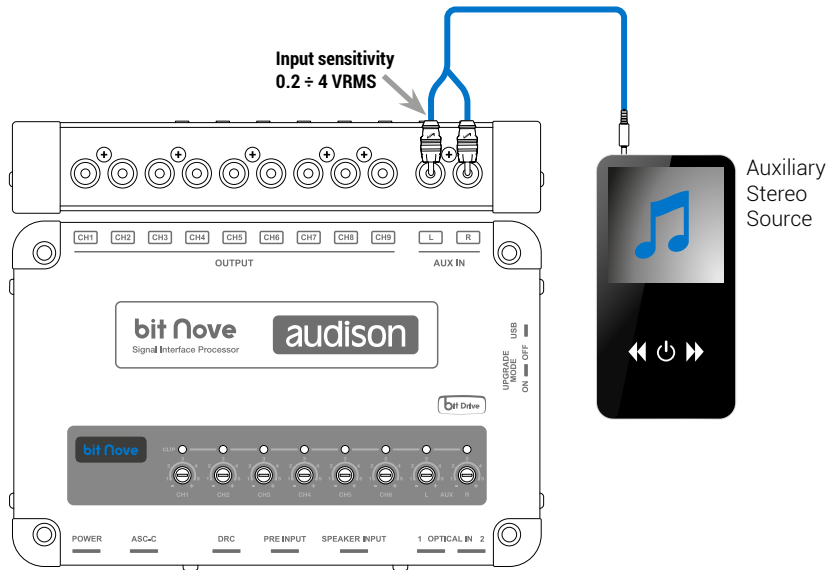

5.3 DIGITAL OPTICAL INPUT SIGNALS

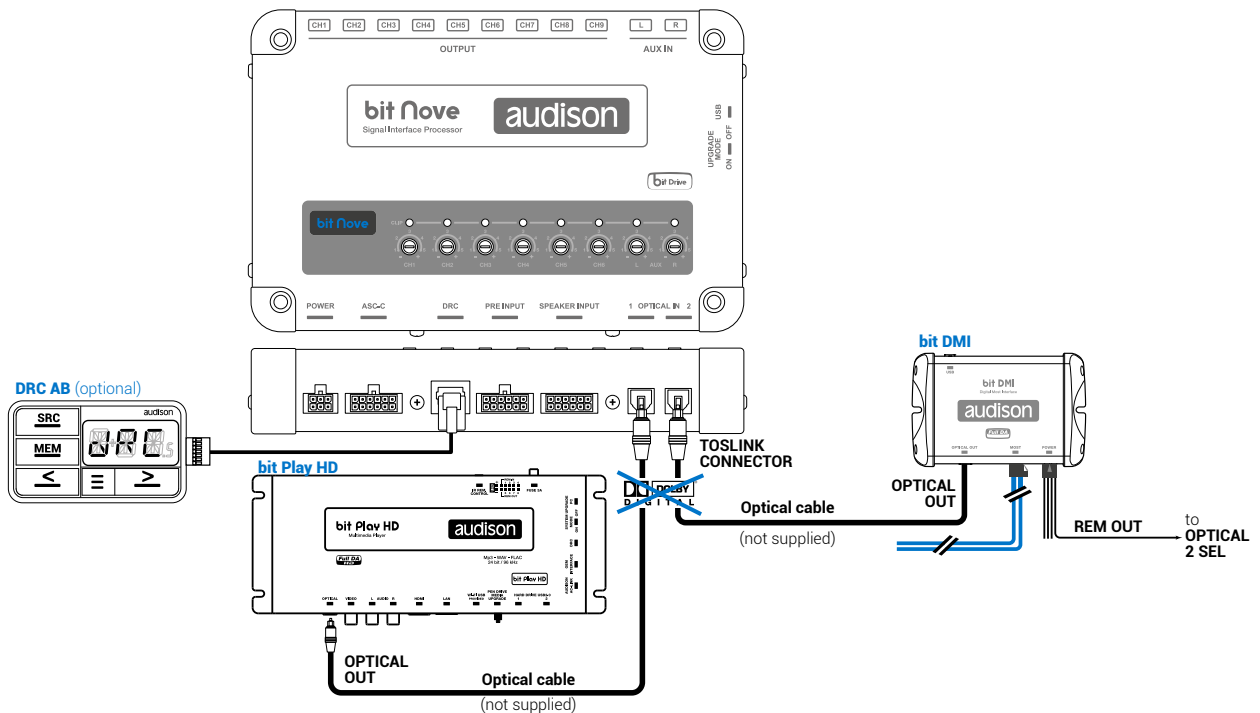

WARNING: the digital input accepts up to 192 kHz / 24 bit stereo PCM signals. So DOLBY DIGITAL (AC3) multi-channel signals coming from audio/video sources (such as the audio of a film in DVD) or DTS can not be reproduced. The output of these devices will therefore have to be set in STEREO mode for the signal to be reproduced.

How to select OPTICAL input:

1. Using the DRC, selecting the **OPTICAL 1/2** input.
2. Using the **OPTICAL 2 SEL** terminal to select the OPTICAL 2 INPUT.
This command is activated by connecting the terminal to + 12V.

5.4 OUTPUT SIGNALS

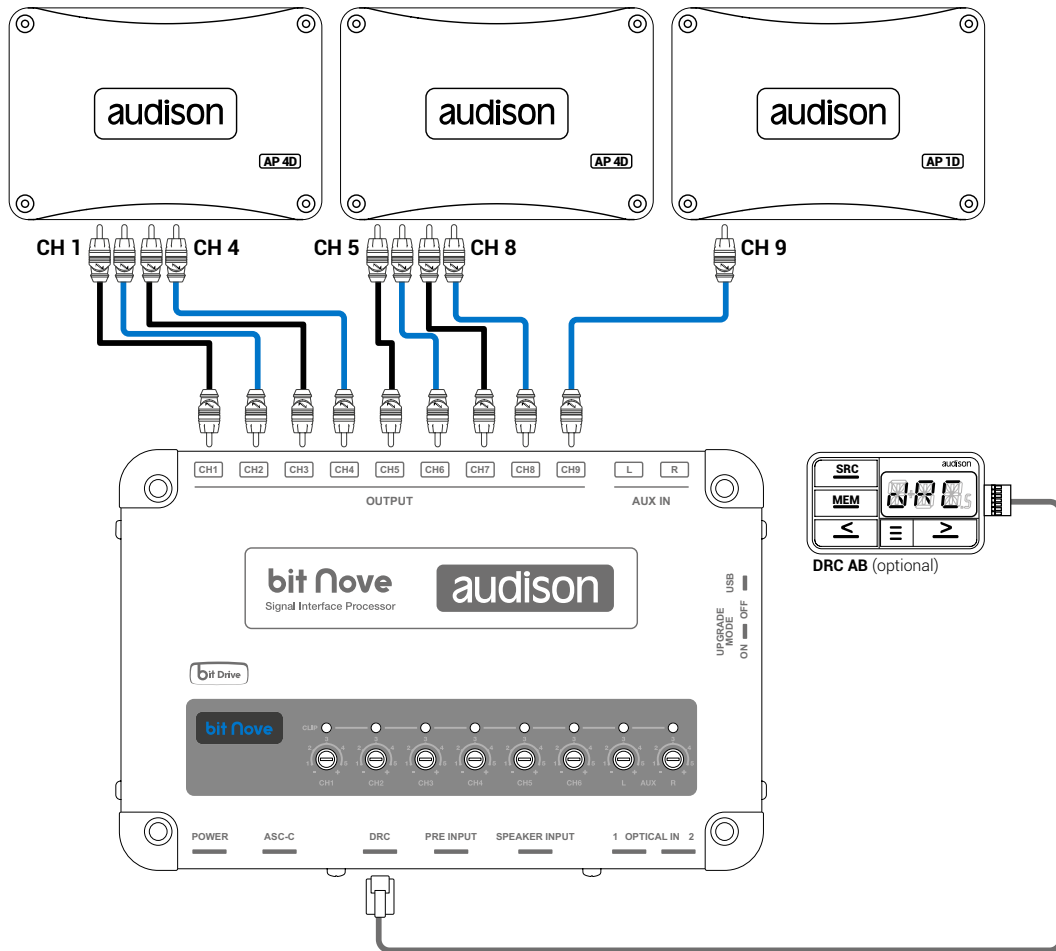

OUTPUT	TYPE	CUT FILTER	FILTER TYPE	CUT FREQUENCY	TIME ALIGNMENT
CH 1	Front Left TW	HI PASS	LINKWITZ	3000HZ@12dB	0 cm
CH 2	Front Right TW	HI PASS	LINKWITZ	3000HZ@12dB	0 cm
CH 3	Front Left Mid	BAND PASS	LINKWITZ	500Hz@12dB / 3000HZ@12dB	0 cm
CH 4	Front Right Mid	BAND PASS	LINKWITZ	500Hz@12dB / 3000HZ@12dB	0 cm
CH 5	Front Left WF	BAND PASS	LINKWITZ	80Hz@12dB / 500HZ@12dB	0 cm
CH 6	Front Right WF	BAND PASS	LINKWITZ	80Hz@12dB / 500HZ@12dB	0 cm
CH 7	Rear Left	HI PASS	LINKWITZ	80Hz@12dB	0 cm
CH 8	Rear Right	HI PASS	LINKWITZ	80Hz@12dB	0 cm
CH 9	SUBWOOFER	LO PASS	LINKWITZ	80Hz@12dB	0 cm

MASTER INPUT CONFIGURATION

IN 1	Front Left
IN 1	Front Right
IN 3	Rear Left
IN 4	Rear Right
IN 5	Not Connected
IN 6	Not Connected

AUXILIARY INPUTS

OPTICAL 1 Input	ENABLED
OPTICAL 2 Input	ENABLED
AUX Input	ENABLED

5.5 PERSONAL COMPUTER AND DIGITAL REMOTE CONTROL (DRC)

1. Connecting the bit Nove to the PC and DRC

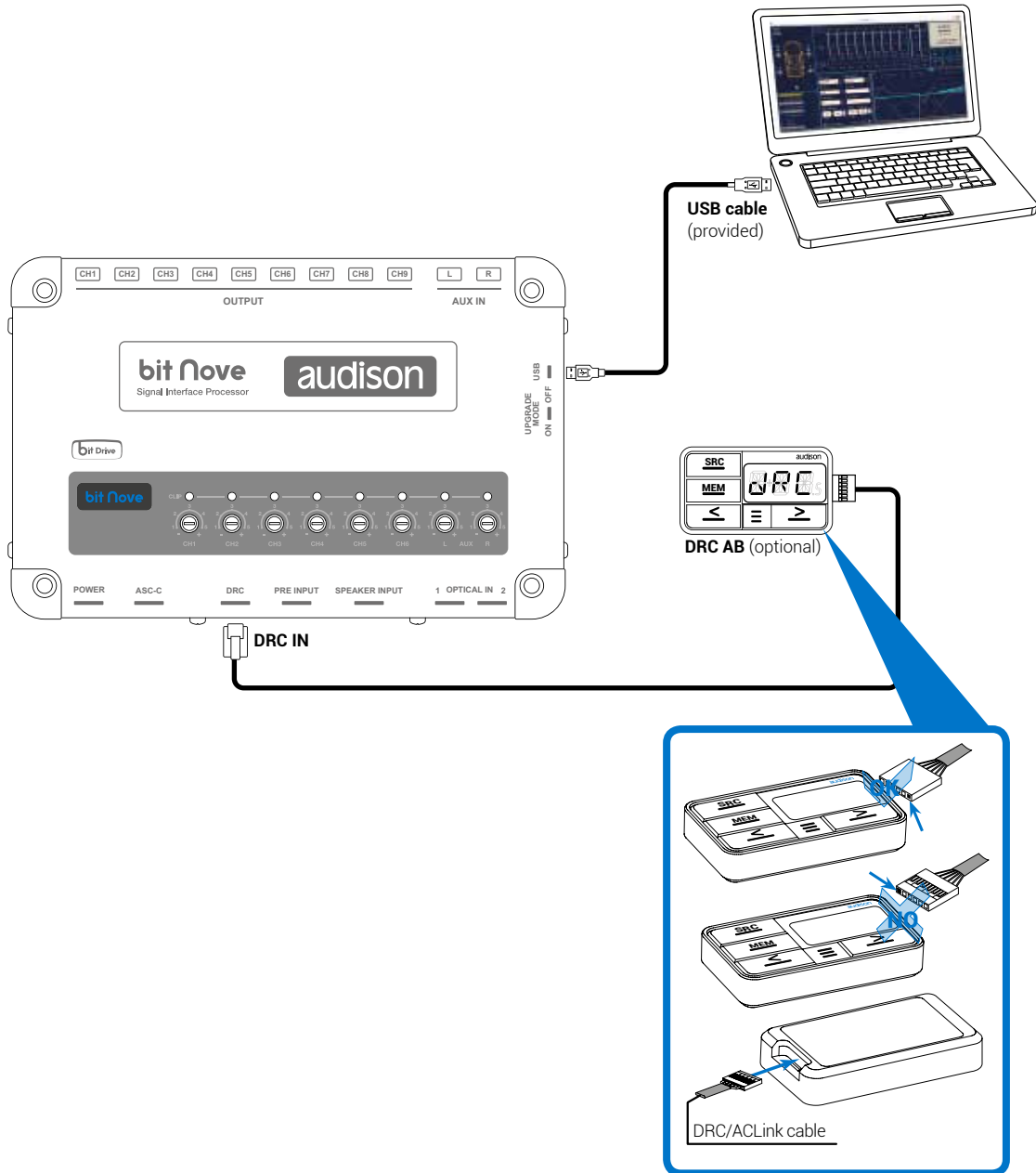

6. GUIDE FOR INSTALLING/UNINSTALLING Prima SOFTWARE AND DRIVERS

6.1 GUIDED PROCEDURE FOR PC SOFTWARE INSTALLATION

1. Insert the "bit Nove Setup CD 1.0" in the drive on the PC you wish to use.
2. **Windows Vista:** access Computer from the Windows **START** menu;
Windows 7: access Computer from the Windows **START** menu;
Windows 8 / 10: access the **Desktop** from Windows 8 / 10 **MAIN** menu;

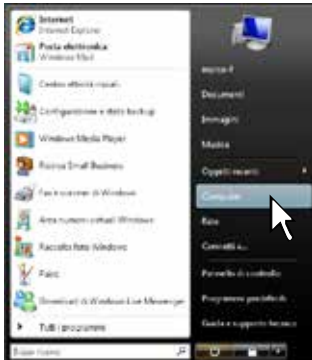

Windows Vista



Windows 7



Windows 8 / 10

3. **Windows Vista:** right click on the icon for the "bit Nove Setup CD 1.0" and click on **Explore**;
Windows 7: right click on the icon for the "bit Nove Setup CD 1.0" and click on **Open**;
Windows 8 / 10: access **Computer** from the Windows 8 / 10 menu;



Windows Vista



Windows 7



Windows 8 / 10

4. **Windows Vista:** double click on the **setup** icon;
Windows 7: double click on the **setup** icon;
Windows 8 / 10: select the CD drive and double click on the **setup** icon;



Windows Vista



Windows 7

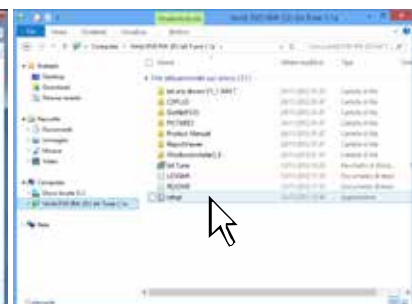

Windows 8 / 10

5. **Windows Vista:** select **I AGREE** to continue with the installation or **CANCEL** to interrupt it;
Windows 7: select **I AGREE** to continue with the installation or **CANCEL** to interrupt it;
Windows 8 / 10: select **I AGREE** to continue with the installation or **CANCEL** to interrupt it;



6. **Windows Vista:** select **INSTALL** on the tab and then **NEXT**;
Windows 7: select **INSTALL** on the tab and then **NEXT**;
Windows 8 / 10: select **INSTALL** on the tab and then **NEXT**;

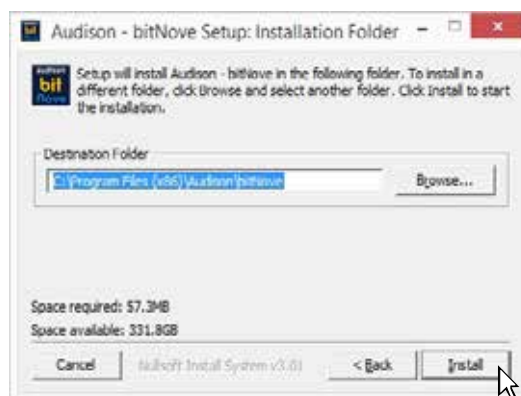

8. **Windows Vista:** follow and complete the installation procedure and click **CLOSE** at the end of the installation;
Windows 7: follow and complete the installation procedure and click **CLOSE** at the end of the installation;
Windows 8 / 10: follow and complete the installation procedure and click **CLOSE** at the end of the installation;

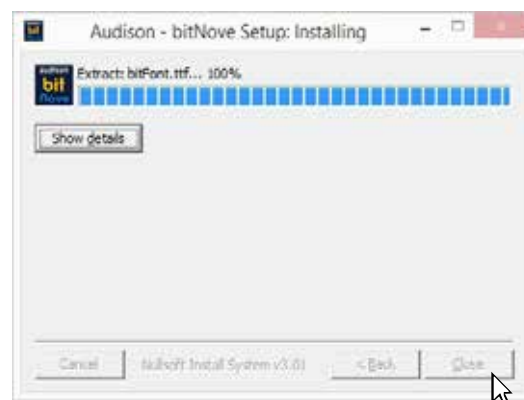

6.2 GUIDED PROCEDURE FOR DRIVER INSTALLATION

1. Turn the **bit Nove** on.
2. Connect the USB cable on the **bit Nove** connector to a free USB port on the PC.

WARNING: when connecting a laptop via USB to the **bit Nove** while it is turned on, the laptop has to work with its own battery and stay disconnected from the mains adapter (external power supply). Once the connection between the laptop and **bit Nove** has been established, you can immediately connect the computer, if necessary, to the mains adapter.

3. **Windows Vista:** the PC will recognize the **bit Nove** interface and installation will start automatically;

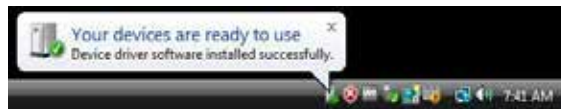

Windows 7: the PC will recognize the **bit Nove** interface and installation will start automatically;

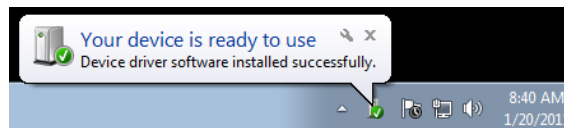

Windows 8 / 10: the PC will recognize the **bit Nove** interface and installation will start automatically;

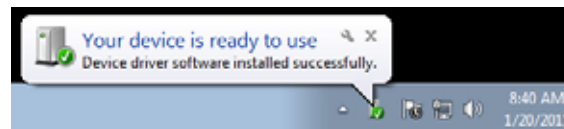

4. The peripheral device has been installed correctly and is ready for use.

***Remark:** **bit Nove** uses the HID drivers already built into Windows. For this reason, they are not included on the CD and will always install automatically.

6.3 UNINSTALLING bit Nove SOFTWARE

Procedure 1

To uninstall the **bit Nove** PC software you can use the link in the menu:

Start / All programs / bit Nove / uninstall

Procedure 2

To uninstall the **bit Nove** PC software, you can also use the standard procedure:

Start / Control Panel / Uninstall or change a program / bit Nove / remove.



7. HOW TO SET UP THE BIT NOVE USING A PC

7.1 OFFLINE MODE

OFFLINE mode can be used to analyze the software without connecting the **bit Nove** to the PC to become familiar with the numerous functions of the processor. (For specific functions, see **TARGET** mode [section 7.2](#)). To activate the **OFFLINE** mode, the device must be disconnected from the PC. The software is preset to start with a 3 way active FRONT + REAR full multi-amplified system. To set a new "virtual" system and thus change the inputs and select the outputs, select the function **Configuration Wizard** in the **SETTINGS** window of the software main menu.



Remark: Change the size of the window for the PC software.

- To make the window full-screen, click on the Enlarge button  or double click on the title bar of the PC Software window.
- To restore the previous size from full-screen, click on the Reset button  or double click on the title bar on the window.
- To resize the PC Software window (make it smaller or larger), position the mouse pointer on one edge or corner of the window. When the mouse pointer becomes an arrow with a double point, drag the edge or corner to make the window larger or smaller.



7.2 TARGET MODE

In order to configure the inputs, amplified and pre-amplified power outputs, EQ and time delays for **bit Nove**, it must be interfaced with the PC. When you get to this point you must already be aware of what type of system you intend to set up. In order to change these choices at a later date, you will need to perform the guided procedure again.

The guided procedure will request:

- The type of specialization for the main input channels used. The guided procedure changes according to your choice.
- The type of signals that will be assigned to the main inputs (e.g.: Front Left or Center or Subwoofer, etc.).
- The speakers in the system (e.g.: 3 way Front or Sub Stereo or 2 way Rear, etc.).
- If there are passive crossovers that manage groups of speakers (e.g.: 3 way systems with active midrange).
- If you intend to use an external monophonic amplifier to drive a Subwoofer or an external amplified subwoofer.
- If you intend to use the **bit Nove** amplified outputs in BRIDGE configuration, thus increasing the power on the output.

WARNING: during this operation, we recommend disconnecting the **PRE OUT** connection.



1. Connect the speaker outputs or the source **Pre Out** outputs to the **bit Nove INPUTS** terminal ([see sec. 5.2](#)). Before turning the system on, make sure the PRE outputs are disconnected from the **bit Nove** to avoid damaging the speakers during calibration.

The input calibration operation must be performed with the vehicle engine running. In this case, the voltage is about 14.0 V. The source will provide an undistorted output signal at higher volume.

2. Turn the **bit Nove** on and connect the USB cable to the PC. Start the **bit Nove** software by clicking on the icon on the PC Desktop that was created upon installation.

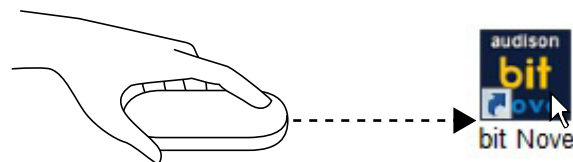

3. If synchronization is successful, a communication window will appear showing the data exchange between the processor and software. Wait a few seconds.

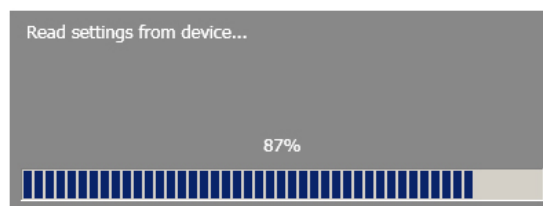

4. Click on the **Settings** menu and select **Configuration Wizard**.

Press **Start** to continue with the configuration.
Press **Cancel** to exit the procedure.

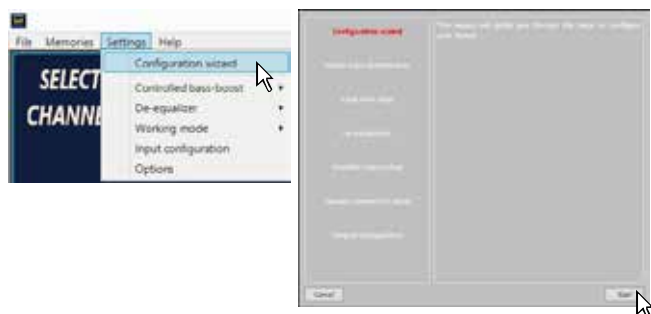

5. Input Configuration

Any of the input channels on **bit Nove** can be given the name corresponding to the signal coming from the source.

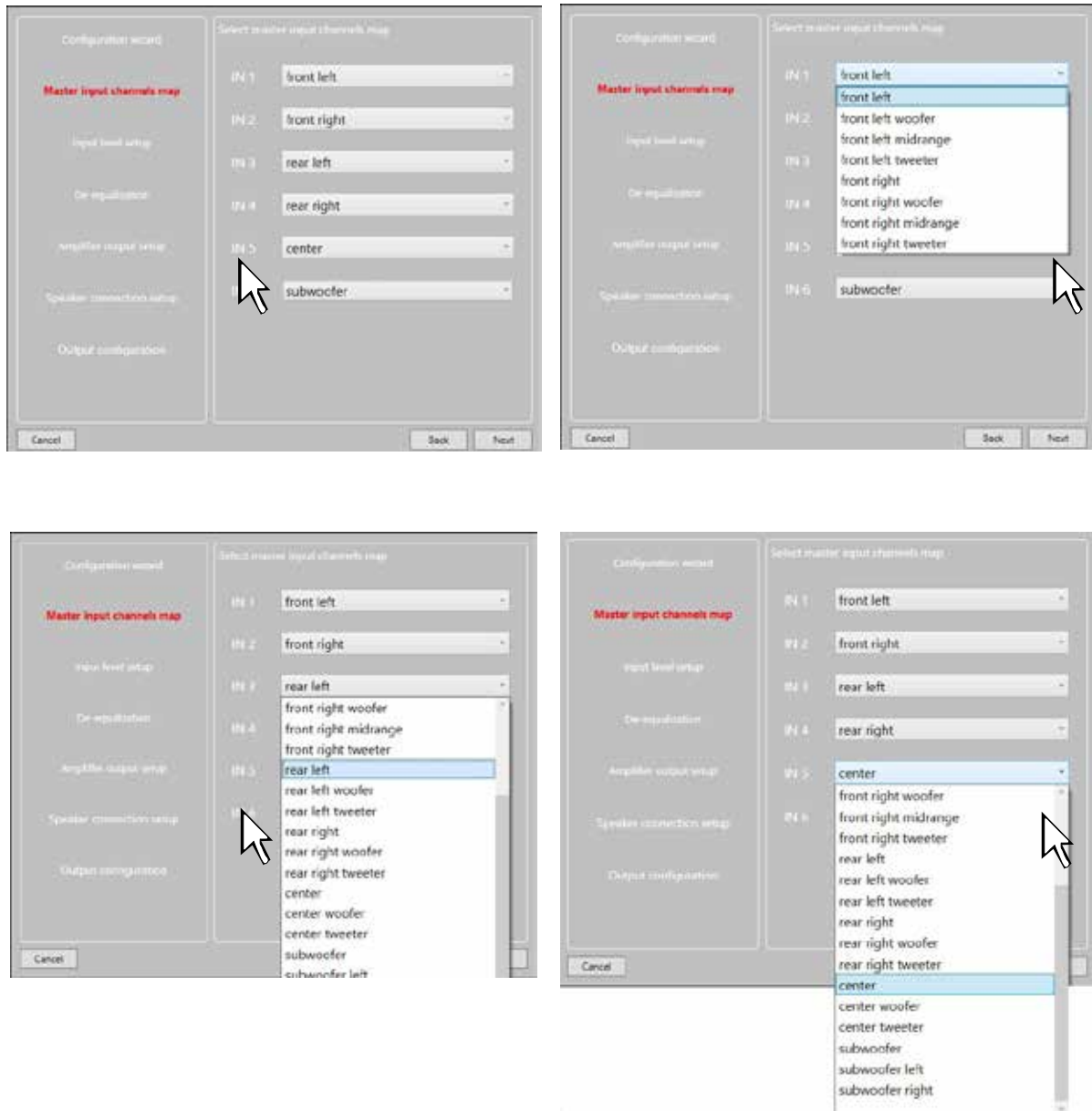

The **bit Nove** will use these names to reconstruct a full band signal coming from an OEM source with a dedicated multichannel amplifier and to assign the corresponding signal to the respective output.

Press **BACK** to return to the previous step.

Press **NEXT** to continue with the configuration.

Press **CANCEL** to exit the procedure.

6. Input Level Setup

- Play track 1 from the CD provided with **bit Nove**.
- Set all tone controls to zero (flat).
- Set balance and fader to center.
- Adjust the head unit volume to the maximum undistorted output level.
- If the head unit provides an adjustable equalizer, make sure that the controls are set to zero (flat).

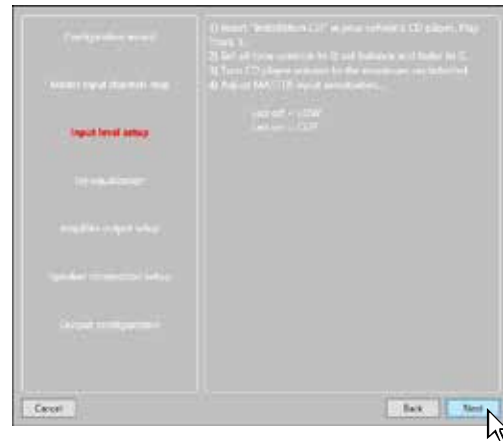

- Press **BACK** to return to the previous step.
- Press **GO** to continue with the configuration.
- Press **CANCEL** to exit the procedure.
- Press **SKIP** to skip the level calibration procedure.

The input level calibration procedure is a delicate operation and must be performed very carefully. If not performed correctly, it can nullify the final acoustic results.

WARNING: the head unit level must be adjusted to the maximum undistorted level. If the initial head unit distortion level can not be determined, adjust the volume to approximately 80% of its maximum. If the head unit output level is set **too low**, the device may produce ground noise (hissing sound) when playing music tracks. This is due to the low signal / noise ratio provided by the head unit to the **bit Nove** input. If you experience this problem, after **calibrating the amplifiers sensitivity levels**, increase the head unit volume and repeat the **bit Nove** calibration procedure as detailed in point 9 of this paragraph.

IN LEVEL calibration for MASTER inputs

This operation is delicate and must be performed with utmost accuracy. An incorrect execution can invalidate the final acoustic results.

- When track 1 of the CD is playing, rotate the first potentiometer to the highest sensitivity (position +).
- As soon as the orange LED lights up or blinks, stop the rotation, turn slightly backwards until the LED turns off.
- Perform the same operation for the other inputs used in the **bit Nove**.

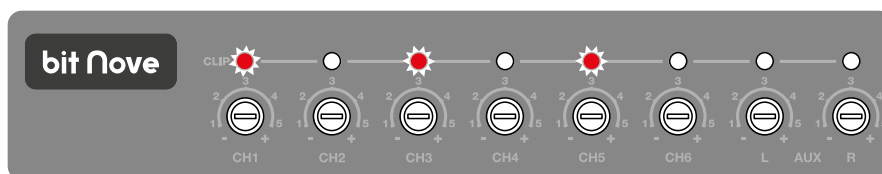

- Brief activations of the LED lights can be considered normal and indicate the correct calibration of the sensitivity.
- Repeat the operation for the other 3 Front / Rear potentiometers.
- Note down the calibration level indicated by the source volume controller.

7. De-equalization

De-equalization of the OEM source, operation not required and not necessary if using low level inputs (Pre out). During the high level input configuration procedure, this function can be used to maximize use of the OEM head units, even if they were equalized to adapt best to the acoustics of the car they are installed in. The de-equalization procedure performs an analysis of the electrical frequency response coming from the various channels on the OEM head unit and automatically applies an equalization opposite to the original one, generating a linear signal that is much more suitable to driving high quality audio systems. Regardless of the input channels used, the de-equalization will be performed by functional groups.

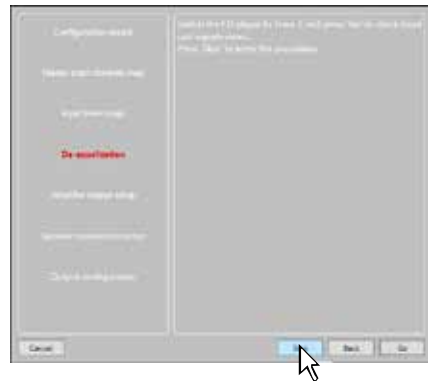

E.g.: even if using Front Left Full and Front Right Full as inputs, the software will also perform the de-equalization on the Rear, Center and Subwoofer since the processor must use the signals identified as Front to also control any possible Rear, Center and Subwoofer outputs.

If you decide to perform this procedure, follow the instructions below:

- Insert the supplied Setup CD if the source used is an audio CD player;
- Play track 2 (press Play);
- Set all tone controls to zero (0);
- Set the balance and fader to the center (0);
- Don't change the adjusted volume previously set through the automatic input level calibration;

- Press **BACK** to return to the previous step.
- Press **GO** to continue with the configuration.
- Press **SKIP** to abandon the procedure.
- Press **CANCEL** to exit the program.

The software uses a progress bar and specific messages to show how the procedure is being executed. At the end of the procedure, the window will show the equalization curves for the head unit.

- Press **BACK** to return to the previous step.
- Press **NEXT** to continue with the configuration.
- Press **CANCEL** to exit the program.

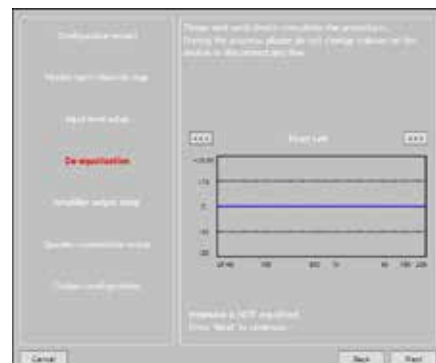

8. Speaker Connection Setup

The speakers in the system can be activated by simply clicking on them. The software assumes that if the Left tweeter, midrange or woofer are selected, the Right ones are also activated. Once the software is started, this choice will affect the crossover type and frequencies with Default settings. If passive crossover filters are not used, each speaker corresponds to an output channel.

Selection of passive crossovers for groups of speakers

The presence of passive crossovers managing functional speaker groups can be indicated.

E.g.: if the audio system features passive crossovers, the software will ask you to set them by clicking on , otherwise press **NEXT**. A 2 or 3 way passive crossover occupies a single output channel.

If the sum of the crossovers and/or speakers exceeds the occupation of 8 PRE output channels, the software will not allow you to proceed with the next operation. Check the crossovers configuration again or, using **BACK**, the speakers setup.

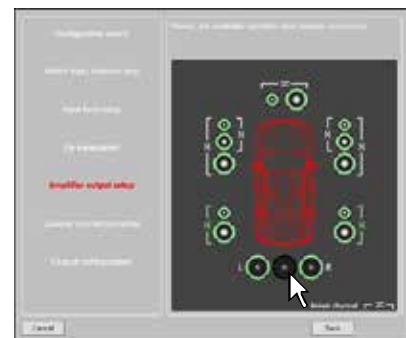

WARNING: one coaxial speaker is considered as a
 Tweeter + Woofer + 2 way passive crossover.

9. Output Configurations

bit Nove features 9 output channels. In this specific step of the procedure you can assign any signal to one of the output channels.

E.g.: The 3 way front can be controlled as:

- multi amplified (6 output channels are needed);
- passive midrange + woofer amplified separately (4 output channels are needed);
- 3 way passive (2 output channels are needed).

During the selection, the software will automatically notify that the 9 output channel limit has been respected, the warning message will disappear and the **NEXT** button will appear.

For convenience, if output 1 is assigned to the left Tweeter, the software will automatically assign output 2 to the right Tweeter. During the procedure, if the left midrange speakers are also assigned to output 1, the software will display a warning message. Simply change the assignment of one of the two numbers in red and the software will automatically position it to the first available channel.

Press **BACK** to return to the previous step.
 Press **NEXT** to continue with the configuration.
 Press **CANCEL** to exit the procedure.

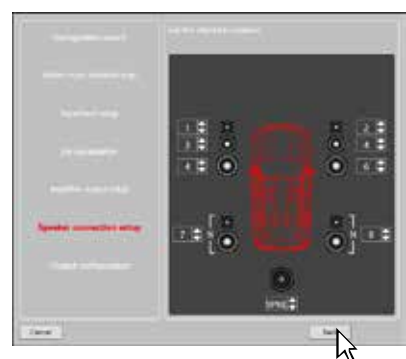
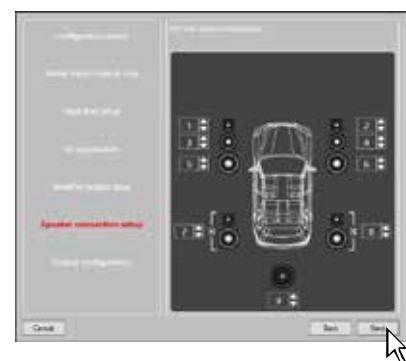

10. Finish

Stop playing the Test track and remove the setup CD from the source player.

Press **BACK** to return to the previous step.

Press **CANCEL** to exit the procedure.

Press **FINISH** to end the configuration.



11. Software startup

The software transfers the settings selected during the guided procedure to the central processor memory.

At the end of this operation, an update confirmation will appear.

Press **OK**.

The product will now have to be finalized to avoid losing the data saved during calibration ([see sec. 7.3.5.2](#)).using the function **FINALIZE** the device.



7.3 ADJUSTING ACOUSTIC REPRODUCTION

The following paragraphs describe the functions to adjust the system and its acoustic fine tuning.

WARNING: when exploring the functions, do not change the parameters on **bit Nove**. Take your time to get familiar with the possibilities the software offers.



If you choose to leave the speakers/amplifiers connected to the **bit Nove**, remember to make adjustments with a general volume that won't damage the other speakers in the system. (see sec. 7.3.13.6)

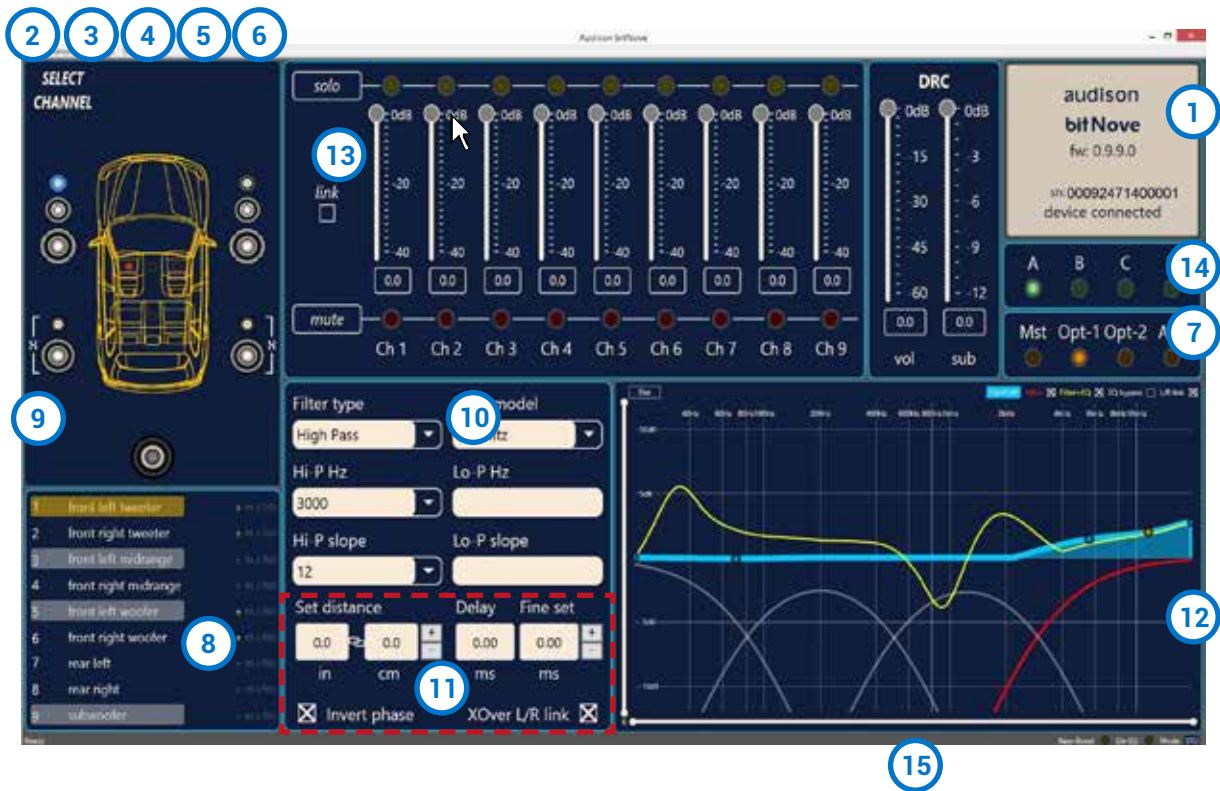

7.3.1 DEVICE INFO

1

This window shows whether the **bit Nove** is properly interfaced with the PC and the DRC. It also shows the Firmware version for the device and the Serial Number.

7.3.2 FILE MAIN MENU 2

By clicking on the File tab, a drop-down menu appears with the entries shown in the image:

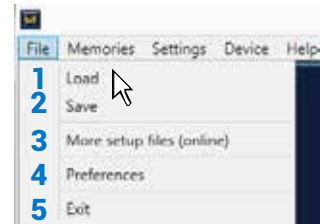

1. **Load:** it loads the entire **bit Nove** configuration from a previously saved file (e.g.: "bit Nove setup1.bt9"). This function is present in both **TARGET mode** and in **OFF LINE** mode. In **TARGET** mode it can reload all of the previously saved settings. This function is useful if you wish to install another **bit Nove** with the same settings. The input level calibration and, possibly, the De-Eq levels must be repeated. In **OFF LINE** mode, you can check the previously saved settings.

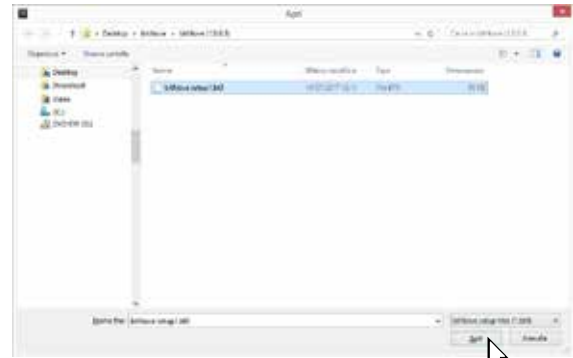

2. **Save Setup:** it saves the entire **bit Nove** configuration for **bit Nove** in one file (e.g.: "bit Nove setup1.bt9"), that can be reloaded on the **bit Nove** later using the **Load Setup** function. This function is available in both **TARGET** mode and in **OFF LINE** mode.

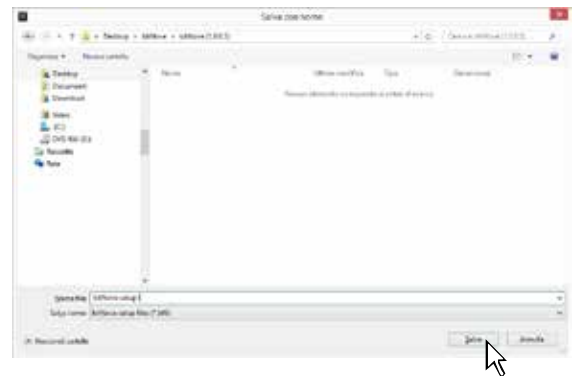

3. **More setup files (online):** this function requires an internet connection. By clicking on this entry, a link to download new installation setups appears.
4. **Preferences:** it allows you to display the context messages in the chosen "Language" (Italian or English). The PC Software automatically defaults to English. To change the language, select language from the menu and restart the PC Software.

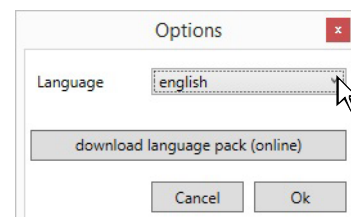

Remark: other languages may also be available. Verify through "**Check for Updates**"

5. **Exit:** exits the PC software.

7.3.3 MEMORIES MAIN MENU 3

By clicking on this item, a drop-down menu appears with the entries shown in the image:

1. **Copy** memory.
2. **Reset current memories:** resets the crossover and standard equalizer values, the ones proposed at the end of the configuration procedure.
3. **Load memory from file:** it loads a previously saved memory, by placing it in one of the two available memories.

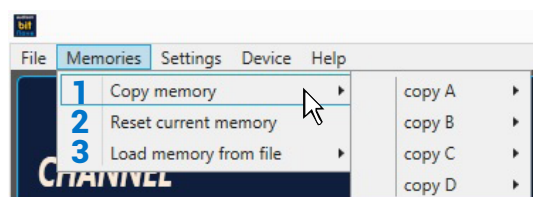

7.3.4 SETTINGS MAIN MENU 4

By clicking on this item, a drop-down menu appears with the entries shown in the image:

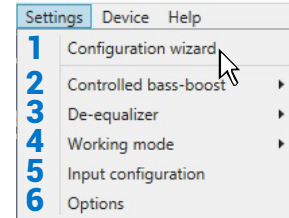

1. I/O Configuration Wizard: sets up the system, and puts the **bit Nove** in the conditions needed to be able to perform this operation (see sec. 7.2).

WARNING: whenever performing the *I/O Configuration Wizard*, the values set in the Options menu are set to the default values.



2. Controlled bass-boost: if enabled, through this function you can operate on the equalization of sub channel and woofers. By clicking on Settings you can choose the parametric equalizer pole where you can operate and vary the "Q" factor by acting on the wheel of the mouse if it features that function. When heavy equalization is set, the software will activate through soft clipping eliminating the subsequent distortions. This function can also be enabled and disabled via DRC MP.

Bass boost Sub Woofer

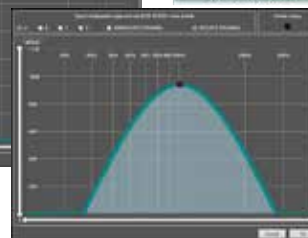
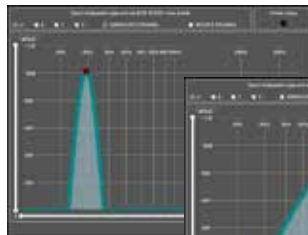

Bass boost Woofer

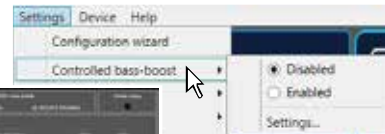

3. De-Equalizer: if activated (*Enabled*), this function enables the de-equalization curve calculated during the **Configuration Wizard**. If the function is deactivated (*Disabled*) no source de-equalization curve is applied. The **Reset** command deletes the de-equalization curve calculated during the **Configuration Wizard**.

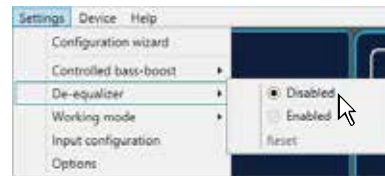

4. Working Mode: the software can work in two modes, acting on the crossover filter section.

Standard: simplified mode with some restrictions easing the use of the software (see sec. 7.3.10).

Expert: there are no restrictions in the use of software functions (see sec. 7.3.10).

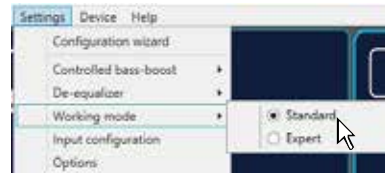

WARNING: switching from one mode to another resets the configuration of the filters to their original Default setting.



5. Input configuration: shows the specialization assigned to the inputs on **bit Nove** during the **Configuration wizard**.



6. ON / OFF settings: function to set up the **bit Nove** turn on parameters.

- **ART (auto remote turn on / off) enable:** selecting Enabled the bit Nove is turned on through the amplified output (BTL) of a source connected to the FL-FR inputs. This function can be deactivated by selecting Disabled.

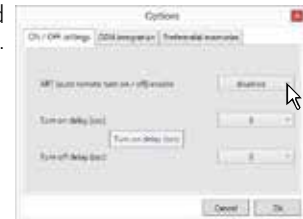

- **Turn On delay (sec):** it is the delay between turning on the device and activating the output audio. Each amplifier, upon turn on, has its own delay before being operational. Setting **Turn On delay** to a value equal or higher than the longest of these delays, you will have a synchronized activation of the entire audio system.



- **Turn Off delay (sec):** it is the delay between the REMOTE OUT signal deactivation and the **bit Nove** shut down. It is not usually essential to manage this parameter but it can be useful to decrease it in case there are amplifiers producing a "bump" noise upon switch off.

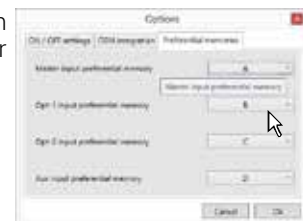

- **OEM integration:** function to set up the automated commutation of the audio system Master input.

Auto select Master input (muted Head Unit): this function is activated by selecting Enabled and allows the automated commutation on the Master input when the signal is available.

Return delay (sec): function to set up the automated deactivation delay for the Master input.

Master Input level (db): set up of the signal level for the Master input when it is enabled by the "**Auto select master input**" function. It is possible to select among levels of intervention from 0 dB to -18 dB.

Preferential memories: this control panel enables the assignment of a memory for each input available on the **bit Nove**.

7.3.5 DEVICE MAIN MENU 5

By clicking on this item, a drop-down menu appears with the entries shown in the image:

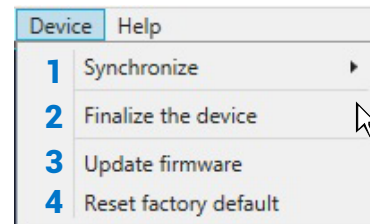

1. Synchronize: this function synchronizes the PC with the **bit Nove** and vice versa due to communication losses caused by the device shutting down or for other reasons.

Read from Device: the PC loads the settings present in the **bit Nove** memory to the PC Software.

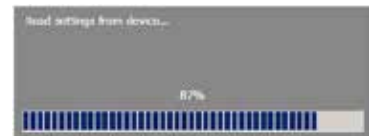

Write to device: the PC loads the current settings on the **bit Nove** memory.

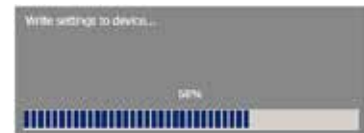

2. Finalize the device: it allows you to load all of the parameters set during system calibration in the internal memory, letting the **bit Nove** operate without being connected to the PC.

When Finalize to **bit Nove** is performed, the software provides a warning message that the data previously saved in the **bit Nove** will be overwritten.



- Click on **YES** to load the data.
- Click on **NO** to interrupt the procedure.

3. Update firmware: this allows firmware updates on **bit Nove** (see sec. 8.3.2).

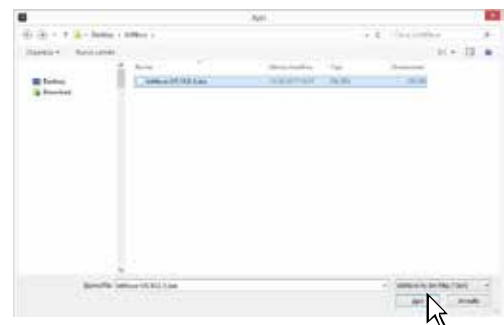

4. Reset factory default: performs full reset of **bit Nove** returning the product to its original conditions, deleting all previously saved data from the processor memory.



7.3.6 HELP MAIN MENU 6

By clicking on this item, a drop-down menu appears with the entries shown in the image:

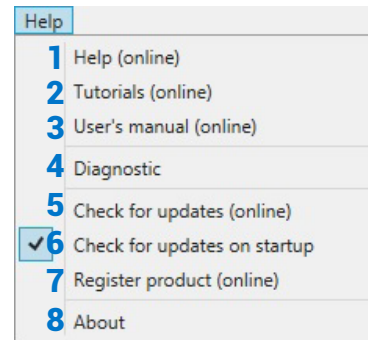

- 1) **Help (online):** this function requires an internet connection. By activating this function and moving the mouse pointer to the various sections of the graphic interface for the PC software, the concerned area will be highlighted in red. By clicking on the red area, a link will activate, opening up the default browser, displaying the paragraph of the manual related to that specific area. The manual will be displayed in the language selected in FILE-> PREFERENCES (see sec. 7.3.2)



- 2) **Tutorials (online):** this function requires an internet connection. Clicking on this item activates a youtube link to consult audio/video information regarding the product.
- 3) **User's Manual (online):** the internet browser installed in your PC will open up and a research for the URL www.audisonbitdrive.eu will automatically start, offering the possibility to check the product manual online.
- 4) **Diagnostic:** this function must be used exclusively if requested by the Audison authorized service centre. It generates a file named "xxxxxxxxx.dng" that is saved on the PC desktop, to diagnose the product. This function is useful to fix installation issues remotely.
- 5) **Check for Updates:** connects to the website www.audisonbitdrive.eu and checks for updates to the **bit Nove** Software/Firmware in order to be able to update the device in use (see sec. 8.3). To perform this operation, the PC must have an active internet connection.
- 6) **Check for Updates on startup:** when enabled the availability of new firmware/PC Software updates is checked automatically each time you start the program.
- 7) **Register product:** this function requires an internet connection and opens the default browser to the page for registering the product and creating a personal account in the "bit Drive" portal. This operation only needs to be performed once; then you can access your account through the Login Account.
- 8) **About:** it shows information regarding the **bit Nove** software in use.



7.3.7 SELECTED INPUT 7

The "Selected Input" window shows the active source during connection with the PC. This can be used to select the desired source. Once disconnected from the PC, you can select the input source through the DRC or through the external functions "MASTER ENABLE" and "OPTICAL ENABLE".



7.3.8 CHANNEL MAP 8

This window shows the name attributed to the output channels. The window is active. You can click on it to manage the individual channel that, once selected, will be highlighted. If you hold down the CTRL key and click on another channel, it will also be selected and highlighted. At the same time, the filter curve will appear on the graph area. Multiple selection is only allowed for functional groups, except for the Subwoofer, which can be selected together with any group.

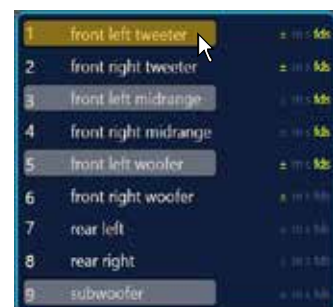

E.g.: front Left Full together with Subwoofer, but not with Rear Left Full.

If you wish to check the electrical response of the Rear system together with the Subwoofer, you must clear the Front system selection. However, the software will only let you operate on a single channel and will show the message "EDIT" in red to the side of the channel that you can operate on. More specifically, the graph will show the electrical responses from the only crossover related to the channel being edited in red. The overall electrical response from all channels selected will be shown in yellow, taking into account the crossover filters and equalizations. The final result will be shown in green.



To act on another channel without losing the selection, simply click to the right of the desired channel in the EDIT column. The CHANNEL MAP window also lets you mute the individual channels by clicking on MUTE to the left of the desired channel.

If MUTE is active on the channel, "m" is shown in red.

If the SOLO function is active, "s" is shown in green.

If there are time delays on the channel, "fds" is shown in yellow. A channel can also be selected as shown in the outline in the image (see sec. 7.3.9).

7.3.9 SELECT CHANNEL 9

This window is enabled. You can click directly on the speaker or speaker system to be able to display or set the parameters for the individual channel. Once selected, the speaker(s) will be highlighted.

If you hold down the CTRL key and click on another channel, it will also be selected and highlighted as occurs with the "Channel Map" (see sec. 7.3.8). **Listening point visual indicator.**

This window includes the position indicator (in red).

There are four preset points: driver, passenger, front center and rear center for passengers.

The indication only acts as a reference, allowing you to display the listening points for which the digital display calculation was optimized (see sec. 7.3.11). If you set the delays in relation to the "driver" position and then you wish to also optimize the system for the "passenger" position, you must reset the distances in the specific menu since the system does not update them automatically.

If used together with the presets (see sec. 7.3.14) it is useful to try different setups according to the different listening points.

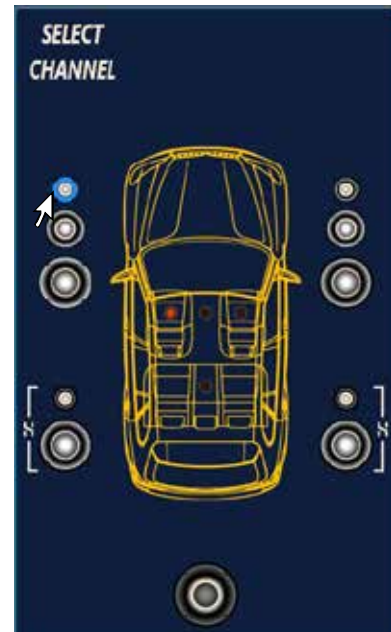

7.3.10 FILTER SETTINGS 10

bit Nove manages nine crossover filters, one for each output channel. Each filter allows you to set the parameters of a single output channel.

1. Xover L/R Link: function to transfer the adjustments made on the Right channel to the Left one and vice versa. To activate it, you must click on the blue light, which will come on. **Xover L/R Link** acts on all of the adjustments of the **Filter Settings** except for **Set Distance (Delay)**.

2. Invert Phase: it inverts the phase of the channel under examination by 180°. This can be done by selecting the green light which will turn on. This can be useful to solve phase alignment problems among the different filtered channels.

3. Filter Type: function to select the type of filter to assign to the channels:

- Full Range
- Low Pass
- High Pass
- Band Pass

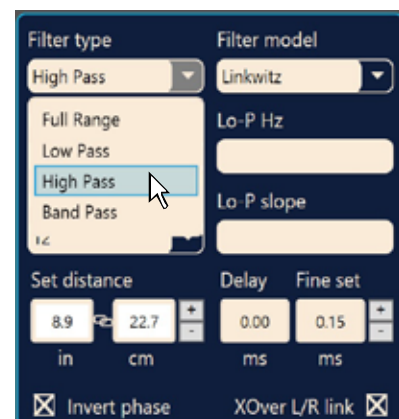

In **STANDARD** mode:

Depending on the speaker or speaker system selected during configuration, a suitable type of filter will be available.

E.g.: for the Front Woofer, only Low Pass or Band Pass will be available. For Front Mid-Hi, only High Pass and Band Pass will be available, etc.

In **EXPERT** mode:

Any speaker system selected has any type of filter available.

WARNING: in **EXPERT** mode, pay attention to the filter selection. Speakers have mechanical limits that must not be exceeded, otherwise it could lead to permanent damage.

When a filter is selected, some optimized cut-off frequencies are set by default to avoid breaking the speakers.

E.g.: if you select Low Pass for a tweeter, the default frequency is suitable for a woofer but not for the tweeter, which could be damaged.

STANDARD MODE

FILTER TYPE ->	Full Range	Low Pass	High Pass	Band Pass
Tweeter			X	X
Midrange				X
Woofer		X		X
Mid-Hi			X	X
Subwoofer		X		X
Full	X	X	X	X

EXPERT MODE

FILTER TYPE ->	Full Range	Low Pass	High Pass	Band Pass
Tweeter	X	X	X	X
Midrange	X	X	X	X
Woofer	X	X	X	X
Mid-Hi	X	X	X	X
Subwoofer	X	X	X	X
Full	X	X	X	X

4. Filter Model: function to select the type of filter to be applied.

- **Linkwitz** (default)
- **Butterworth**

When launching the **bit Nove** software, **Linkwitz** is proposed as the filter model for the speaker or speaker group connected to the related channel. To apply the opposite (Left/Right), enable the Xover L/R Link. If you change the model to **Butterworth**, the change will be applied.

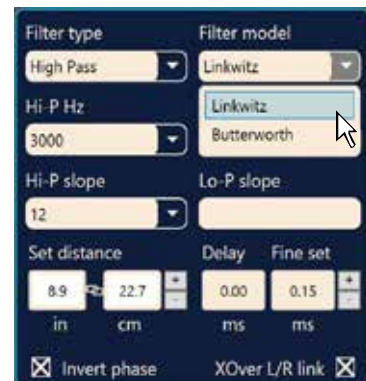

5. Cut-off frequencies

- **Hi-P Hz** 10 ÷ 20000: High-Pass filter
- **Lo-P Hz** 10 ÷ 20000: Low-Pass filter

If you select the **Band-Pass** filter, both the **Hi-P Hz** and the **Lo-P Hz** boxes will be enabled to be able to set the band frequency.

You can select the cut-off frequency by:

- clicking on the related drop-down menu, selecting the frequency range that includes the value to be set and then clicking on the actual value.
- clicking on the related drop-down menu, selecting the pre-chosen frequency range and then moving from value to value using the arrow keys (up / down) on the PC keyboard.
- clicking twice on the related drop-down menu and then moving from value to value by scrolling with the mouse.

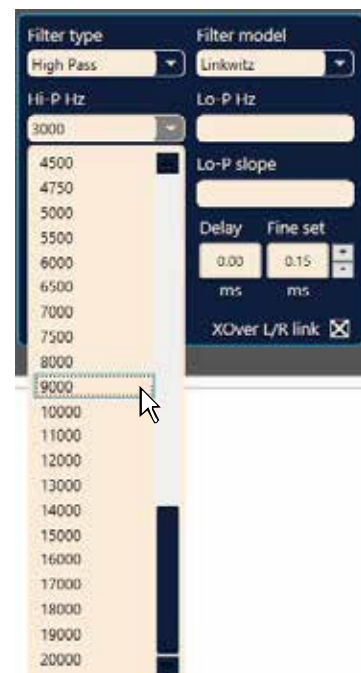

6. Filter slope

- **Hi-P Slope** 12/24 dB/Oct. (Linkwitz) 6/12/18/24dB/Oct (Butterworth)
 - **Lo-P Slope** 12/24 dB/Oct. (Linkwitz) 6/12/18/24 dB/Oct (Butterworth)
- When starting the **bit Nove** software, it offers **Linkwitz** with 12 dB/Oct. slope.

E.g.: if you select Band Pass as the filter type, the same slope will be applied to both the hi-pass and low-pass as the default slope, but they can also be unbound.

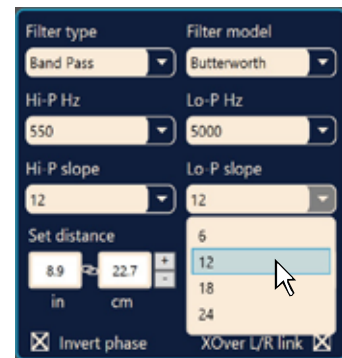

The crossover filter response related to the selected channel is displayed graphically by a yellow curve, as shown in the examples below.

E.g. Band Pass

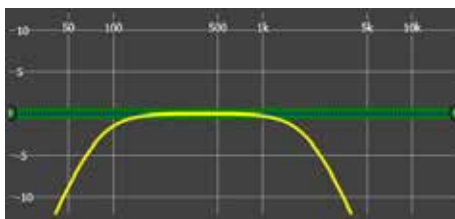

Crossover Frequency 80 - 2000 Hz @ 12 dB Oct.

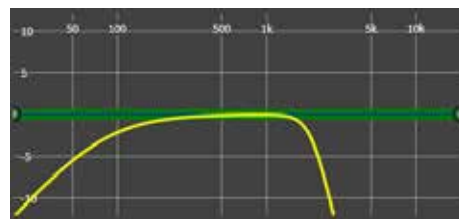

Crossover Frequency 80 Hz @ 6 dB Oct. Hi-pass
2000 Hz @ 24 dB Oct. Low-pass

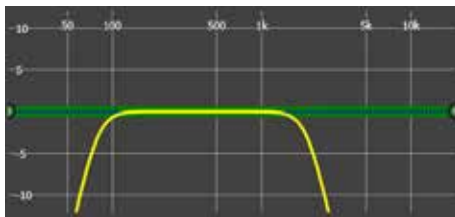

Crossover Frequency 80 - 2000 Hz @ 24 dB Oct.

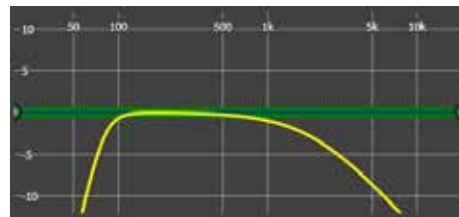

Crossover Frequency 80 Hz @ 24 dB Oct. Hi-pass
2000 Hz @ 6 dB Oct. Low-pass

7.3.11 SET DISTANCE AND DELAY

11

This setting is based on an automatic system that calculates the time needed for the sound to get from the speaker to the listener's ear.

Preliminary remarks

Sound moves through the air at a speed of 343 m/sec (1.125 ft/sec.) at a temperature of 20° C (68° F). If you know the distance from the sound emission point, you can then calculate the time the sound takes to get to the listener's ear.

If you set the distances of the different speakers, the **bit Nove** will automatically change them into time (ms - milliseconds). It does not assign a delay (0.0 ms) to the farthest speaker (usually the Subwoofer) and progressively growing delays as much as the other speakers get closer to the listening point, in order for all the emission points to reach the listening point at the same time.

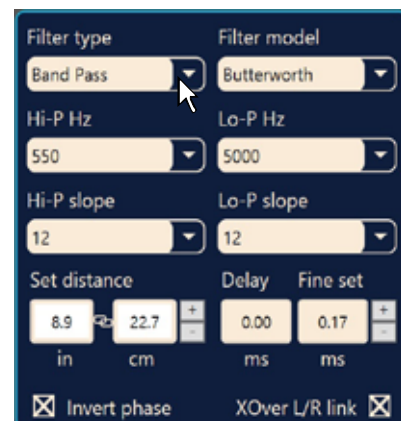

SET DISTANCE

Function to set the distance between the speaker and the listening point. Choose cm (centimeters) or in (inches). The "Set Distance" boxes can be set using the cursors.

DELAY ms/default

Displays the time in ms (milliseconds) calculated according to the distance.

DELAY ms/fine set

the **bit Nove** time delay calculation system also lets you perform manual fine tuning.

Preliminary remarks

Fine set and Phase delay

Delay assignment according to distance calculation is theoretical.

Small variations must be applied due to small errors in distance measurement, back-wave reflections inside the car and, primarily, the speaker phase problem.

Two speakers reproducing two frequency areas that are close to each other (e.g.: Woofer and Midrange) will simultaneously reproduce the same frequencies in their crossing area, at a attenuated level. Due to the different nature of the speakers, they will have a phase difference that, for a short frequency interval, acts as a time delay. By using **"fine set"**, you can partly correct these **Phase Delay** problems.

By using the **"fine set"** button, you can change the automatically set delay time.

The delay is increased (+x.xx) or decreased (-x.xx) by the delay value shown in the window "Delay/default" and does not change the value shown, which is the one that is automatically assigned.

Assigning a positive value (+x.xx) using **"fine delay"** means increasing the delay for that speaker and thus moving it farther away from the listening point. Likewise, assigning a negative value (-x.xx) means decreasing the speaker delay and thus moving it closer to the listening point.

In order for you to see how much **"Fine Set"** has been manually changed, both delay values are shown. To see the resulting delay, physically applied to the output, you have to add the values shown in the **"Delay / Default"** and **"Delay / Fine Set"** boxes. A negative value (decreasing the delay) can not be assigned to the farthest speaker; it can only be assigned to the other speakers as they are all already delayed compared to the farthest one. If you attempt to give the farthest speaker a negative value, a warning message will appear (Fig. 1).

When using **"fine set"** "fds" will appear in green on the corresponding channel on the **"Channel Map"** (Fig. 2)

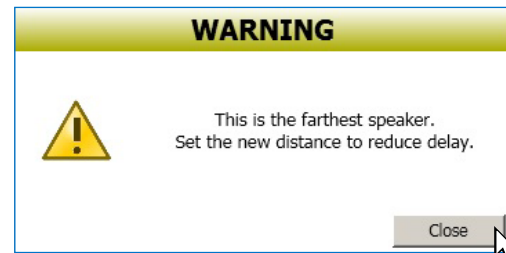

(Fig.1)



(Fig.2)

Example of setting the time delay (Fig. 3):

1. Choose the system listening point.
To identify the listening point, choose an ideal spot in the center of the listener's head (driver or passenger).
For the front center and rear center, choose a point between the two listeners.
2. Measure the distance in a straight line from each speaker or group of speakers compared to the listening point. For each speaker, choose the center of the mobile membrane as the emission point.
For groups of speakers, choose a point between them. It will then be possible to fine tune it using the Fine Set function.
3. On the Channel Map, select the channel related to the speaker under examination and enter the respective distance in the Set Distance box in the Filter Settings menu.
4. Repeat step 3 for each channel.

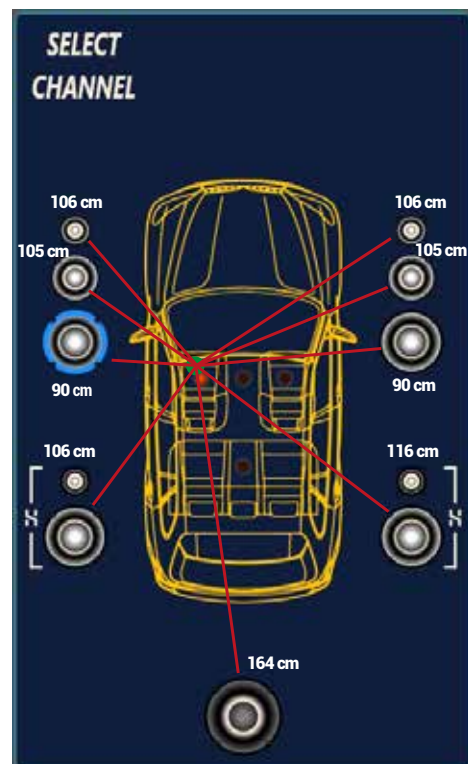

(Fig.3)

5. Once the time delay settings are complete, start the musical reproduction and use the Fine Set box, moving the values up or down (except for the subwoofer since it is the farthest speaker) to fine tune the system for optimal sound. We recommend listening to various types of music (percussion, melodic, etc.) for better evaluation of the coherence (spatial stability) of the different musical instruments.
6. Once the time alignment procedure is complete, you can work on the output equalizer ([see sec. 7.3.12](#)) to optimize the system response based on the level alignment of the various frequencies.

Remark: measurements for the above operations can also be taken using a spectrum analyzer with a suitable microphone. The results must be evaluated and optimized through listening tests.

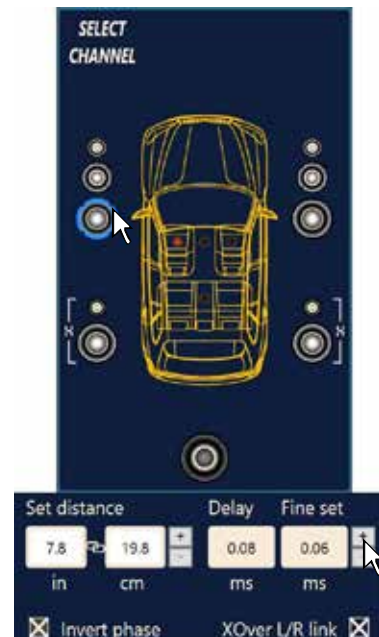

WARNING: if, once you have set the distances for the "driver" listening point, you click on the "passenger" listening point, the **bit Nove** will not re-calculate the delays for the new reference point because the buttons available in the **SELECT CHANNEL** diagram are merely descriptive. Their only purpose is to remind you that you have set the delays for that listening point!

7.3.12 PARAMETRIC EQUALIZER 12

The **bit Nove** software provides an equalizer, that can be managed from a maximum of 10 graphic control points which automatically place a maximum of 10 parametric equalization points. The quantity of graphic control points used doesn't match the parametric poles quantity, which is determined by the adapting software.

The equalizer works according to the functional groups and so we have the following factory configuration:

- one equalizer for the **Front Tweeter**.
- one equalizer for the **Front Mid**
- one equalizer for the **Front Woofer**.
- one equalizer for the **Rear**.



To be able to change the parameters for the equalizer in order to set an equalization curve, just choose the channel to equalize from the **"Channel Map"** menu, positioning the mouse over the point to be set, and shape the curve using the left mouse button (green curve).

In order to vary the "Q" factor in the selected equalization point, just scroll using the wheel of the mouse featuring that function.

In order to delete the changes, just put the mouse over the point, select it with the left button and press CANC on the PC keyboard.

The equalizer has specific functions that aid and ease the calibration.

- 1 **Flat** brings all the cursors back to the 0 dB position;
- 2 **L/R Link**, when active, applies the equalization curve to both the right and left channel simultaneously.
- 3 **EQ by Pass**, when active, lets you disable the equalizer to check its effect without losing its settings.
- 4 **Filter** lets you display the electrical response subject to filtering (XOVER), by clicking on the box (red curve).
- 5 **Filter + Eq** lets you display the electrical response subject to equalization, by clicking on the box (yellow curve).

Remark: in order to clearly display the set equalization curve, you can increase or decrease the vertical axis (dB) and horizontal axis (Hz) by moving the cursors to the side of them. The default is set to +12 dB and 0-20 kHz.

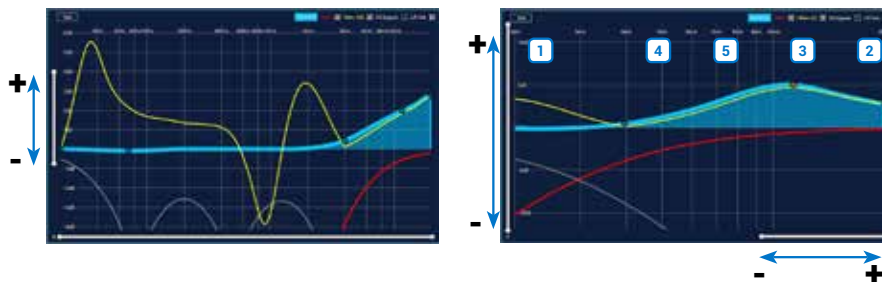

7.3.13 OUTPUT LEVEL 13

This section shows the settings related to the output levels of the **bit Nove** channels. The description of the points shown in the figure is given below.

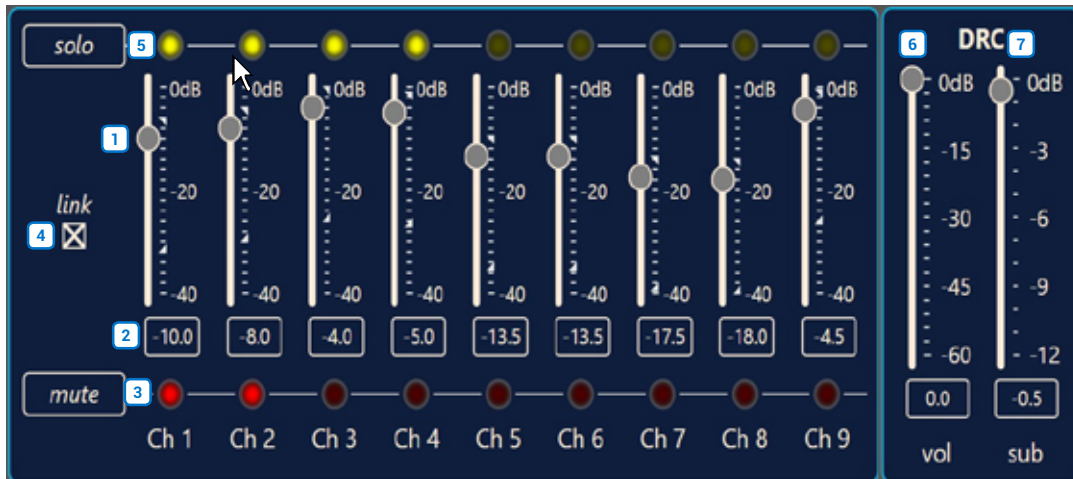

1. Using one of the sliders for the output channels, you can adjust the output level (-40÷0 dB) for each channel. The sliders are enabled based on the output configuration.
2. This part of the display shows the output level for each individual channel (-40÷0 dB), referring to the position of the Slider for the output channels.
3. By clicking on the "Mute" button you can mute the corresponding output channels. By clicking on the "Mute" button again, the mute function will be disabled.
4. By clicking on the "Link" button you can simultaneously adjust all the **bit Nove** output levels. By clicking on the "Link" button again, the function will be disabled.
5. By clicking on the "Solo" button you can mute the output channels except for the one enabled. By manually clicking on the "Solo" button, the function will be disabled.
6. Using the "Volume" slider you can adjust the general output level for the system (-60÷0 dB).
7. Using the "Sub Volume" button you can adjust the output level of the subwoofer (-12÷0 dB), if the system features a subwoofer.

7.3.14 MEMORY 14

The **bit Nove** controls the system configuration, operating by default on memory **A** but gives the option to store and recall for memories (**A, B, C, D**).

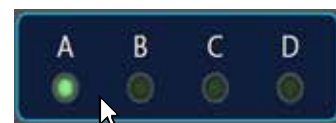

7.3.15 STATUS BAR 15

It is an information area that can be found at the bottom of the PC software window. It shows in real time the working status of the **bit Nove** PC software.

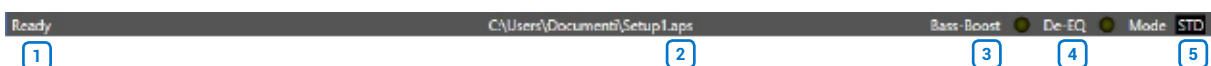

- 1 Indicates the working status of the **bit Nove** PC software.
- 2 Indicates the setup file loaded via PC software on the **bit Nove**.
- 3 **Bass-Boost**: when the LED is lit, the Bass-Boost is enabled [see sec. 7.3.4.2](#).
- 4 **De-eq**: when the LED is lit, the de-equalization curve of the source is enabled [see sec. 7.3.4.3](#).
- 5 **Mode**: indicates whether it is in Expert (EXP) or Standard (STD) mode [see sec. 7.3.4.4](#).

8. TROUBLESHOOTING

8.1 SYNCHRONIZATION WITH A PC

1. bit Nove operating problems

If, when calibrating the system with the **bit Nove** connected to a laptop there are operating problems, try disconnecting the laptop power supply cable.

With the laptop working on battery power you avoid a possible voltage difference in the USB ground between the vehicle (**bit Nove**) and the ground (PC).

2. Connection lost between bit Nove and the PC

If, while calibrating the system with the PC connected to the **bit Nove**, the amplifier is turned off and back on again, the connection is lost and the software cannot finalize the adjustments that were set. To avoid losing the settings, proceed as follows:

- a. Save the setup to a file on the PC using the **FILE / SAVE SETUP** function.
- b. Exit the software.
- c. Turn the **bit Nove** on.
- d. Launch the software again.
- e. Load the setup file again that was saved using the **FILE / LOAD SETUP** function.

3. bit Nove does not respond

If calibrating the system with the PC connected to the **bit Nove** and the latter does not respond to the commands, proceed as follows:

- a. Turn off **bit Nove** by pressing the knob on the DRC or disconnecting the Remote IN or even disconnecting the power cable for a second.
- b. Save the setup to a file on the PC using the **FILE / SAVE SETUP** function.
- c. Exit the software.
- d. Turn the **bit Nove** on.
- e. Launch the software again.
- f. Load the setup file again that was saved using the **FILE / LOAD SETUP** function.

4. Settings not saved

To successfully complete the **bit Nove** configuration and not lose the work done, remember to store the settings made. Access the "**File**" menu from the management software via the PC and choose "**Finalize the device**".

8.2 BACKGROUND NOISE

Loud hissing/background noise.

If there is excessive hissing/background noise, it may be necessary to repeat the setup for the input sensitivity and/or correct the output level calibration. For more details [see sec. 7.2](#).

8.3 FIRMWARE UPGRADE

8.3.1 TARGET MODE UPDATE

If there are product UPGRADES available online, proceed as follows:

- Save the previous setup (if you wish to consult it in OFFLINE mode);
- Start the **bit Nove** PC Software.

1. Access the **"Help"** menu in the PC management software and choose **"Check for Updates"**.
2. When you select **"Check for Updates"**, the internet browser in the PC will open up and will automatically search for the URL: www.audisonbitdrive.eu.

WARNING: the files must be manually downloaded from the website. The software access method may be different from the following. Refer to the instructions on the website.

3. Once the related page is open, click on the LINK for the product.
4. Identify the newest file whose name includes the word Firmware followed by four numbers and click on the specific symbol to start the download. When requested, save the file to the PC.

5. Select "Update Firmware". The program will ask you to select the file that was just saved from the Download Area or that was previously saved in the PC.

WARNING: the **bit Nove** Firmware update procedure may be tricky. It is essential to perform it under the best possible conditions. If the operation is started and prematurely interrupted (e.g.: PC locked up, loss of power to **bit Nove**, accidental disconnection of the USB cable during update), you might need to contact our Customer Service for further support as the **bit Nove** may need to be reprogrammed.

6. Before starting the **bit Nove** update, the program warns you to:
 - not disconnect **bit Nove** from the PC;
 - not disconnect **bit Nove** from power;
 - temporarily disable the PC automatic stand-by processes;
 - temporarily disable the screen saver on the PC;
 - close all running applications;
 - temporarily disable the anti-virus and anti-spyware systems.

7. Once you have clicked on **OK**, the Firmware update procedure starts. This process will last between 30 seconds and 1 minute; the progress bar and the flashing logo on the **bit Nove** will show the updating process status.

WARNING: during the update, the updating process of the progress bar may stop for a few seconds. Do not interrupt the process in any way.

8. When successfully completed, a notification window will appear. In order to be able to use the **bit Nove** again, you must close the program on the PC and turn off the **bit Nove**.

9. Turn the **bit Nove** back on and restart the PC software. If the **bit Nove** firmware update was completed correctly, the dialogue window will show:
 - new **bit Nove** Firmware version.

10. Repeat the product calibration operations if necessary ([see sec. 7.2](#)).

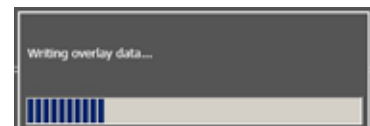
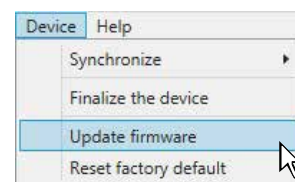
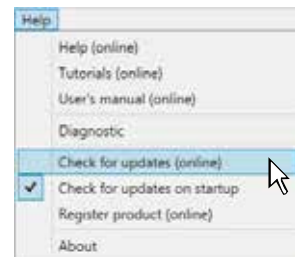

8.3.2 RESCUE MODE UPDATE

In case the **bit Nove** update is not possible, due to interruptions during routine updates, please follow the below instructions:

- Disconnect the Power supply connector on **bit Nove**.
- Set the product upgrade switch to the **"ON" position**
- Connect the Power supply connector on **bit Nove**
- Turn the **bit Nove** on. The logo will start flashing.

Start the **bit Nove** PC Software.

1. Access the **"Help"** menu in the PC management software and choose **"Check for Updates"**.

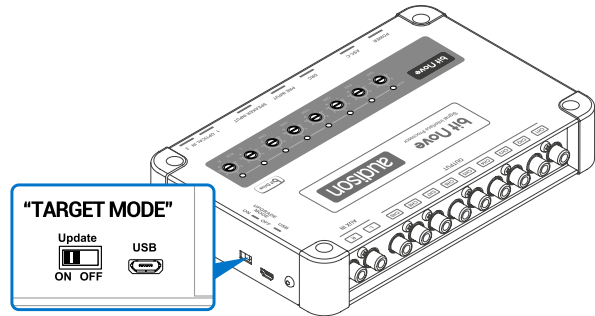

2. When you select **"Check for Updates"**, the internet browser in the PC will open up and will automatically search for the URL: www.audisonbitdrive.eu.

WARNING: the files must be manually downloaded from the website. The software access method may be different from the following. Refer to the instructions on the website.

3. Once the related page is open, click on the LINK for the product.
4. Identify the newest file whose name includes the word Firmware followed by four numbers and click on the specific symbol to start the download. When requested, save the file to the PC.

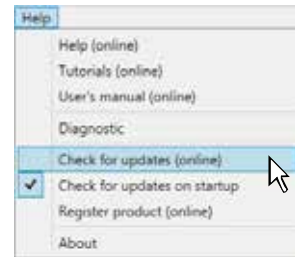

5. Select **"Update Firmware"**. The program will ask you to select the file that was just saved from the Download Area or that was previously saved in the PC.

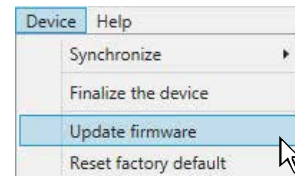

WARNING: the **bit Nove** Firmware update procedure may be tricky. It is essential to perform it under the best possible conditions. If the operation is started and prematurely interrupted (e.g.: PC locked up, loss of power to **bit Nove**, accidental disconnection of the USB cable during update), you might need to contact our Customer Service for further support as the **bit Nove** may need to be reprogrammed.

6. Before starting the **bit Nove** update, the program warns you to:
 - not disconnect **bit Nove** from the PC;
 - not disconnect **bit Nove** from power;
 - temporarily disable the PC automatic stand-by processes;
 - temporarily disable the screen saver on the PC;
 - close all running applications;
 - temporarily disable the anti-virus and anti-spyware systems.

7. Once you have clicked on **OK**, the Firmware update procedure starts. This process will last between 30 seconds and 1 minute; the progress bar and the flashing logo on the **bit Nove** will show the updating process status.



WARNING: during the update, the updating process of the progress bar may stop for a few seconds. Do not interrupt the process in any way.

8. When successfully completed, a notification window will appear.
In order to be able to use the **bit Nove** again, you must close the program on the PC and turn the **bit Nove** off.
Disconnect the Power supply connector on the **bit Nove**.
9. Set the "UPGRADE" switch to the OFF position.
Connect the Power supply connector on **bit Nove**.
10. Turn the **bit Nove** back on and restart the PC software.
If the **bit Nove** firmware update was completed correctly, the dialogue window will show:
- new **bit Nove** Firmware version.
11. Repeat the product calibration operations ([see sec. 7.2](#)).

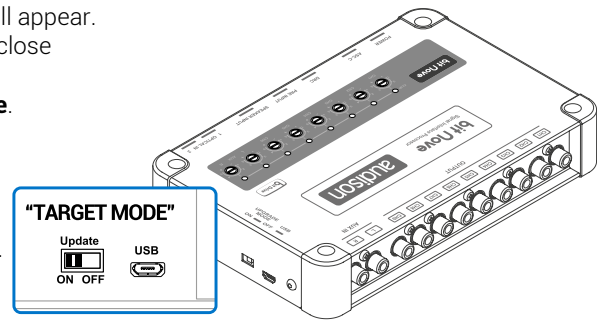

9. TECHNICAL SPECIFICATIONS

POWER SUPPLY	
Voltage	10.8÷15 VDC
Operating power supply voltage	7.5 ÷ 14.4 VDC
Idling current	0.53 A
Switched off without DRC	1 mA
Switched off with DRC	4.5 mA
Remote IN	4 ÷ 15 VDC (1mA)
Remote OUT	10 ÷ 15 VDC (130 mA)
ART (Automatic Remote Turn on/off) - IN from OUTPUT BTL speakers	2 ÷ 7 VDC
SIGNAL STAGE	
Distortion - THD @ 1 kHz, 1 VRMS Output	0.005%
Bandwidth @ -3 dB	10 Hz ÷ 22 kHz
S/N ratio @ A weighted, 4 V Output, 2 V MASTER input	102 dBA
S/N ratio @ A weighted, 4 V Output, 2 V AUX input	101.5 dBA
S/N ratio @ A weighted, 4 V Output, OPTICAL IN1/IN2 input	110 dBA
Channel Separation @ 1 kHz	85 dBA
Input sensitivity PRE / MASTER	1.2 ÷ 8 VRMS
Input sensitivity Speaker / Master	3 ÷ 20 VRMS
Input sensitivity AUX	0.3 ÷ 5 VRMS
Input impedance Pre In / AUX In / Speaker In	15 kΩ / 15 kΩ / 12 Ω
Max output Level 0,1% THD	4 VRMS
INPUT STAGE	
Low level (Pre)	Ch1 ÷ Ch6; AUX L/R
Hi level (Speaker In)	Ch1 ÷ Ch6
Digital	2 x Optical S/PDIF; Max 192 kHz / 24 bit
OUTPUT STAGE	
Low Level (Pre)	Ch1 ÷ Ch9
CROSSOVER	
Filter type	Full / Hi pass / Low Pass / Band Pass
Filter mode and slope	Linkwitz @ 12/24 dB - Butterworth @ 6/12/18/24 dB
Crossover frequency	68 steps @ 20 ÷ 20k Hz
Phase control	0° / 180°
Equalizer (20 Hz ÷ 20 kHz)	
Analog Input Equalizer	Automatic De-Equalization
Output Equalizer	N.9 Parametrics Equalizers: ±12 dB;10 pole; 20 ÷ 20k Hz
Time Alignment	
Distance	0 ÷ 510 cm / 0 ÷ 200.8 inches
Delay	0 ÷ 15 ms
Step	0,08 ms; 2,8 cm / 1.1 inch
CONNECTION	
From / To Personal Computer	1 x Micro USB
To Audison DRC AB / DRC MP	1 x AC Link
Optical 2 sel	Optical In 2 wire control +12 V enable
Mem D sel	Memory D wire control GND enable
GENERAL REQUIREMENTS	
PC connections	USB 1.1 / 2.0 / 3.0 Compatible
Software/ PC requirements	Microsoft Windows (32/64 bit): Vista, Windows 7, Windows 8, Windows 10
Video resolution with screen resize	min. 800 x 600
Ambient operating temperature range	0 °C to 55 °C (32 °F to 131 °F)
SIZE	
W (Width) x H (Height) x D (Depth) mm/inch	130 x 34.5 x 199 / 5.11" x 1.35" x 7.83"
Weight kg/lbs	700 / 1.5

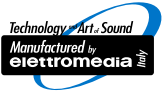

www.audison.eu

audison
ISTINTO
INNOVATIVO

PART OF ELETTROMEDIA
62018 Potenza Picena (MC) Italy
T +39 0733 870 870 - F +39 0733 870 880
www.elettromedia.it